

- ° Profilati in alluminio a disegno/standard/speciali
- ° Dissipatori di calore in barre
- ° Dissipatori di calore ad ALTO RENDIMENTO
- ° Dissipatori di calore per LED
- ° Dissipatori di calore lavorati a disegno e anodizzati
- ° Contenitori porta schede per elettronica in alluminio tipo DIN 43700
- ° Profilati strutturali modulari per robotica
- ° Profilati strutturali modulari per impianti FOTOVOLTAICI

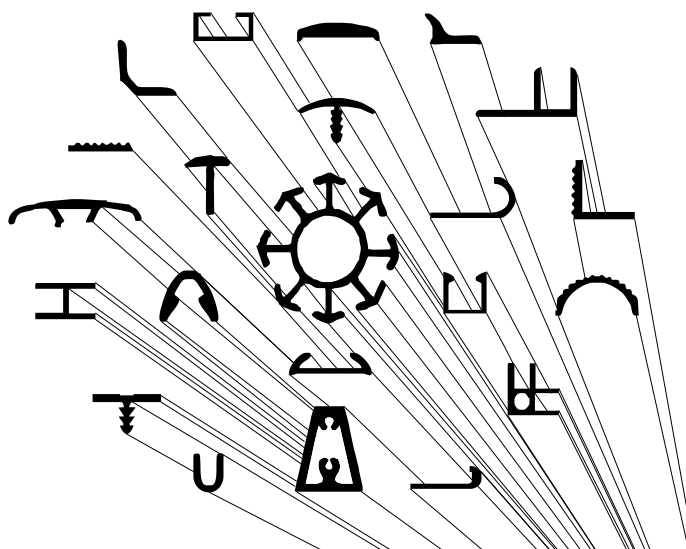

OMAR s.r.l.
PROFILATI ALLUMINIO
ALTA TECNOLOGIA

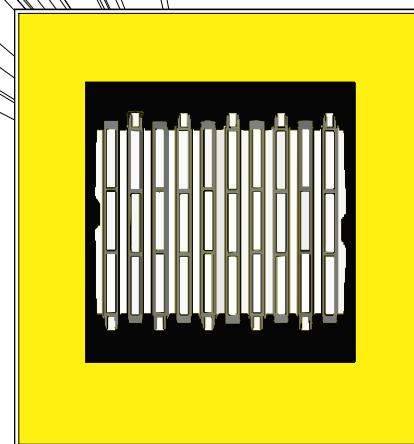

Le "molte forme" della billetta d'alluminio

Dissipatori di calore
ad ALTO RENDIMENTO

Edizione Settembre 2022

Consultate il catalogo aggiornato
 online su:

www.omar-alluminio.it

www.omar-alluminio.com

www.dissipatori.com

° Profilati per pneumatica

° Profilati per stand

° Profilati per battiscopa
 copri fili zoccolini

° Prodotti derivati da profili
 di alluminio

° Lavorazione meccanica
 profili di alluminio

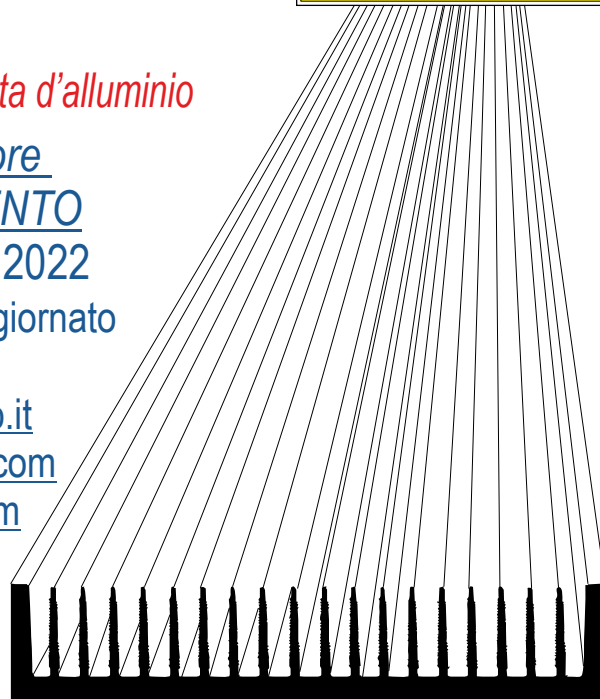

Via Newton, n.12
20016 Pero (Milano - Italy)
Tel.+39 02 3535955 r.a.
Fax.+39 02 3539929
E.Mail: info@omar-alluminio.it

PROFILATI IN ALLUMINIO
 A DISEGNO-STANDARD-SPECIALI



E PER: ELETTRONICA-LED-FOTOVOLTAICO
 AUTOMAZIONE-ROBOTICA-PNEUMATICA-AUTOMOTIVE

DISSIPATORI AD ALTO RENDIMENTO

DISEGNI META' DEL VERO (1:2)- SCALE 1:2

Via Newton, n.12
20016 Pero (Milano - Italy)
Tel. +39 02 3535955 r.a. Fax. +39 02 3539929
E. Mail: info@omar-alluminio.it

Cataloghi Online: www.omar-alluminio.it
www.omar-alluminio.com

PROFILATI ALLUMINIO A DISEGNO / STANDARD / SPECIALI / E PER:
ELETTRONICA / LED / FOTOVOLTAICO / AUTOMAZIONE ROBOTICA / PNEUMATICA / AUTOMOTIVE

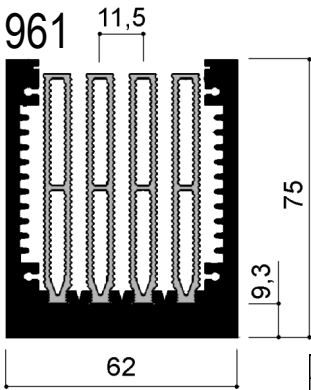

Resistenza termica (KW) in ventilazione forzata

Lg. (mm)	100	200	300
R _{th} a 5m/s	0,23	0,18	0,14

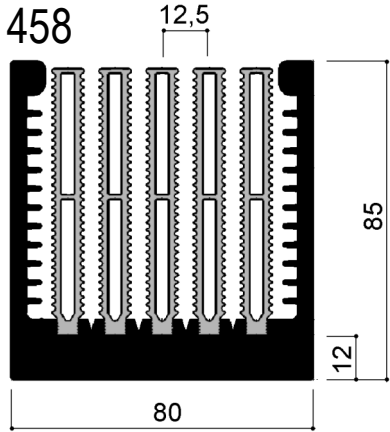
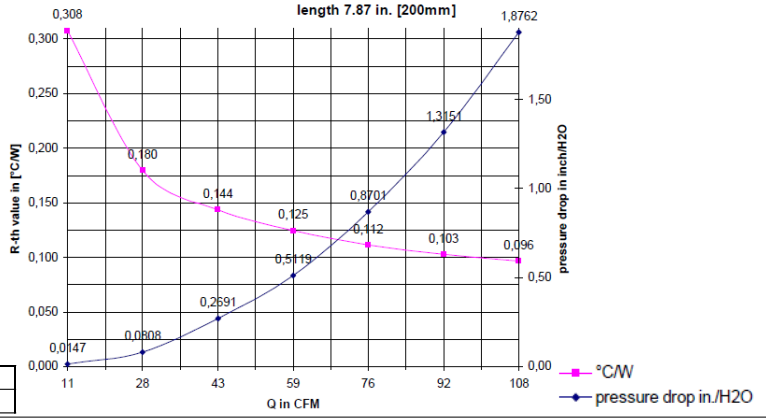

Resistenza termica (KW) in ventilazione forzata

Lg. (mm)	100	200	300
R _{th} a 5m/s	0,165	0,13	0,1

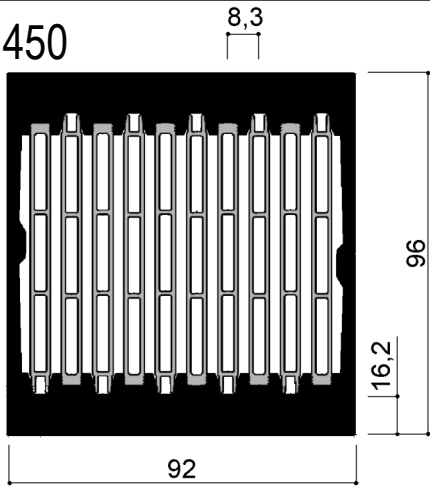
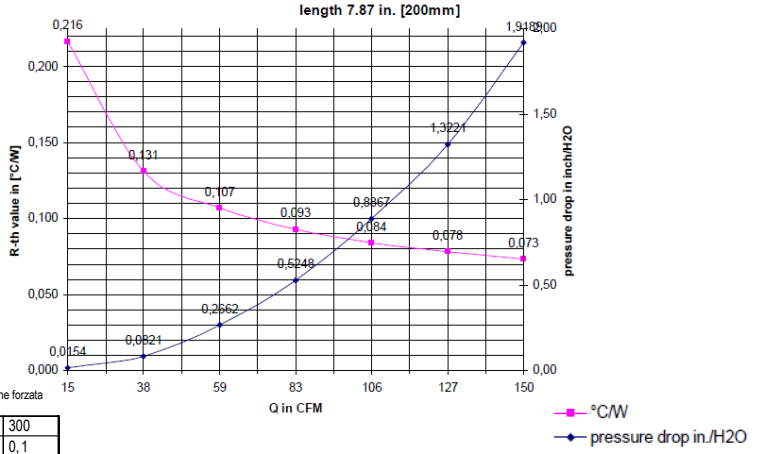

Resistenza termica (KW) in ventilazione forzata

Lg. (mm)	100	200	300
R _{th} a 5m/s	0,13	0,1	0,08

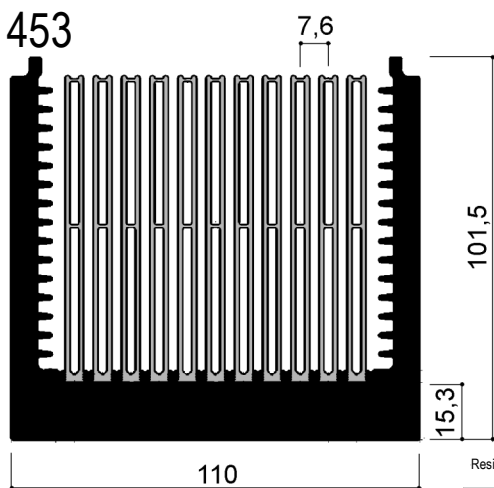
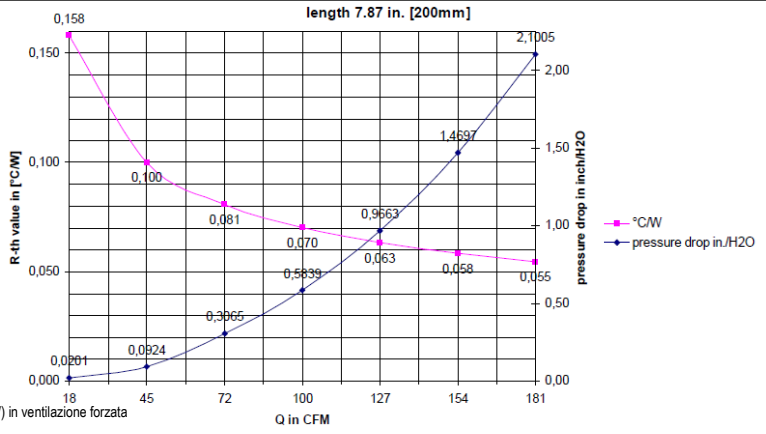

Resistenza termica (KW) in ventilazione forzata

Lg. (mm)	100	200	300
R _{th} a 11m/s	0,0915	0,0579	0,0450

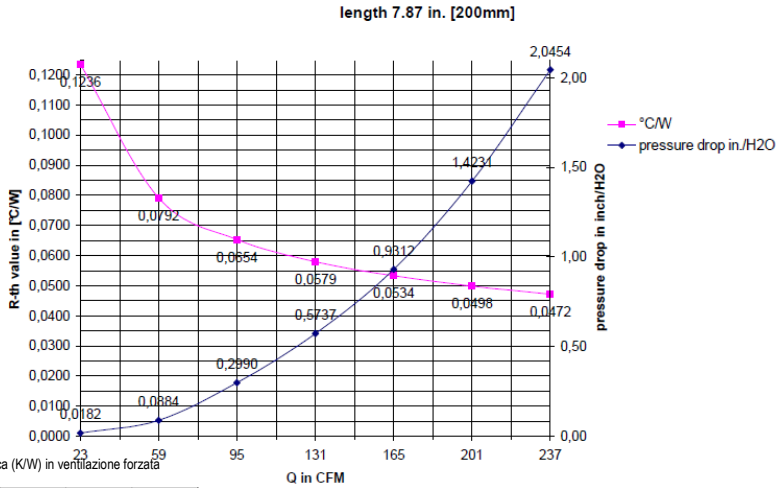

DISSIPATORI AD ALTO RENDIMENTO



DISEGNI META' DEL VERO (1:2)- SCALE 1:2

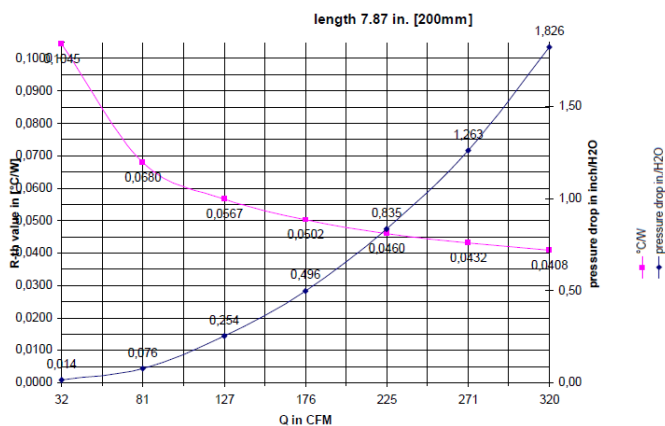
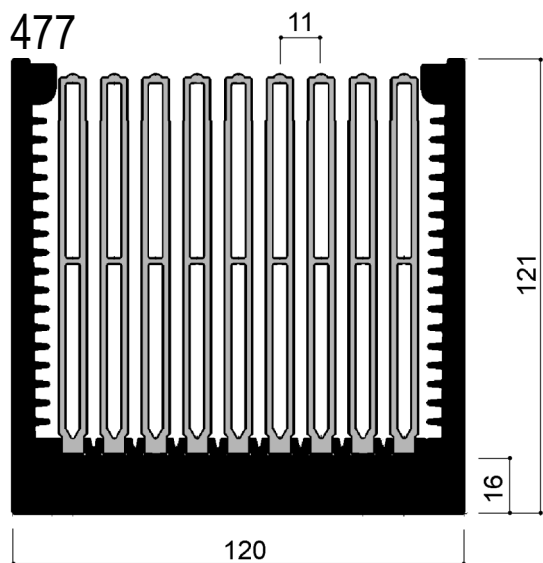

Resistenza termica (KW) in ventilazione forzata

Lg. (mm)	100	200	300
R _n a 5m/s	0,11	0,068	0,052

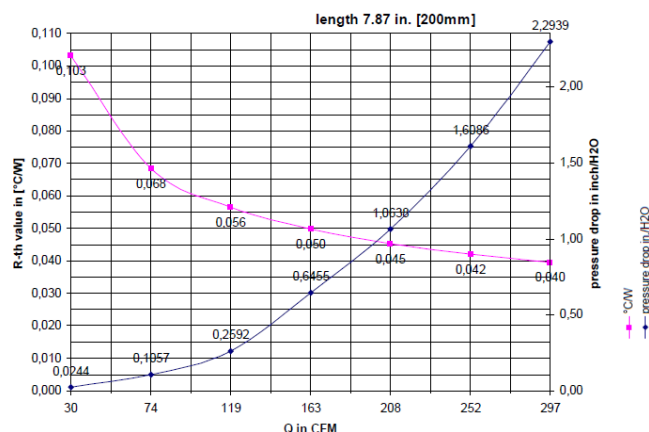
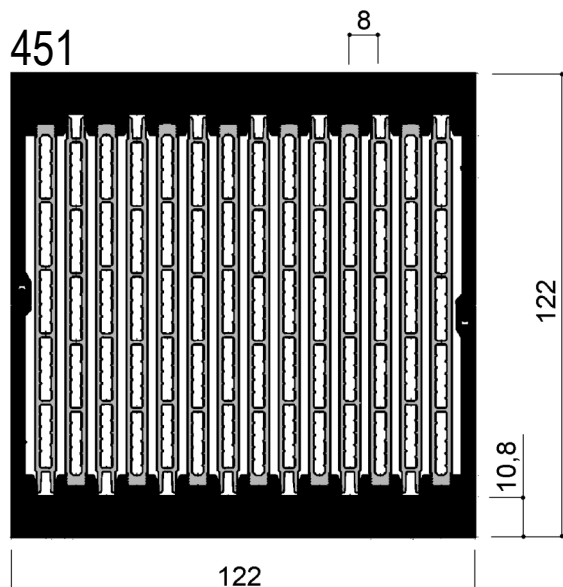

Resistenza termica (KW) in ventilazione forzata

Lg. (mm)	100	200	300
R _n a 5m/s	0,082	0,068	0,052

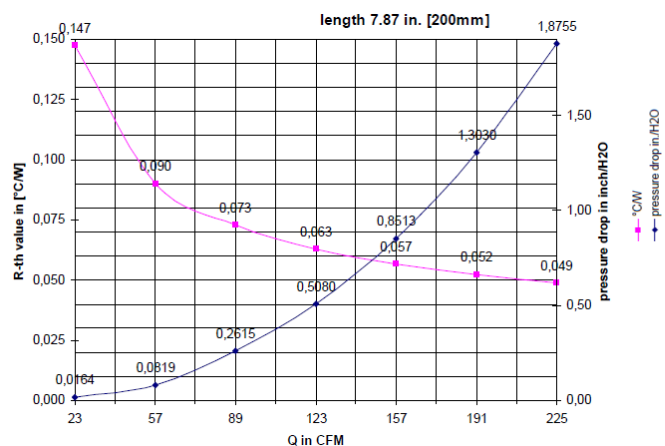
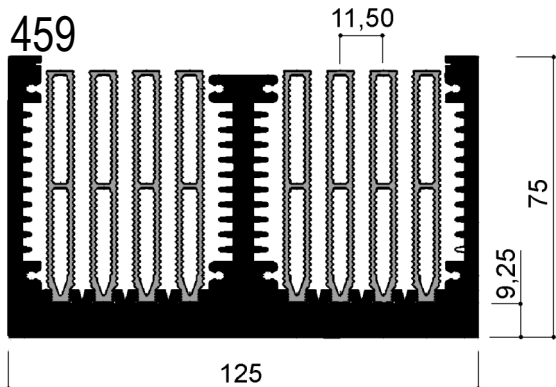

Via Newton, n.12

20016 Pero (Milano - Italy)

Tel. +39 02 3535955 r.a. Fax. +39 02 3539929

E-Mail: info@omar-alluminio.it

Cataloghi Online: www.omar-alluminio.it

www.omar-alluminio.com

PROFILATI ALLUMINIO A DISEGNO / STANDARD / SPECIALI / E PER:

ELETTRONICA / LED / FOTOVOLTAICO / AUTOMAZIONE ROBOTICA / PNEUMATICA / AUTOMOTIVE



DISSIPATORI AD ALTO RENDIMENTO

DISEGNI META' DEL VERO (1:2)- SCALE 1:2

Via Newton, n.12
20016 Pero (Milano - Italy)
Tel. +39 02 3535955 r.a. Fax. +39 02 3539929
E. Mail: info@omar-alluminio.it

Cataloghi Online: www.omar-alluminio.it
www.omar-alluminio.com

PROFILATI ALLUMINIO A DISEGNO / STANDARD / SPECIALI / E PER:
ELETTRONICA / LED / FOTOVOLTAICO / AUTOMAZIONE ROBOTICA / PNEUMATICA / AUTOMOTIVE

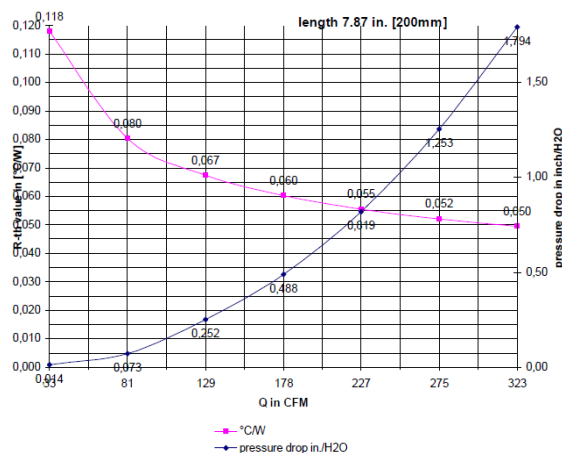
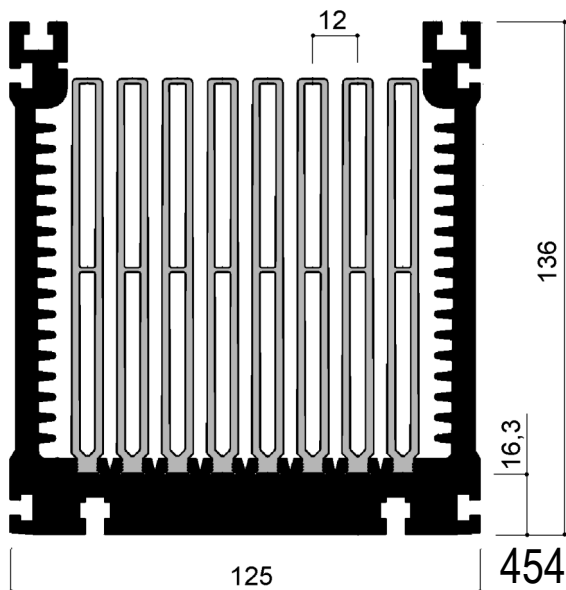

Resistenza termica (K/W) in ventilazione forzata

Lg. (mm)	100	200	300
R _{th} a 5m/s	0,13	0,08	0,06

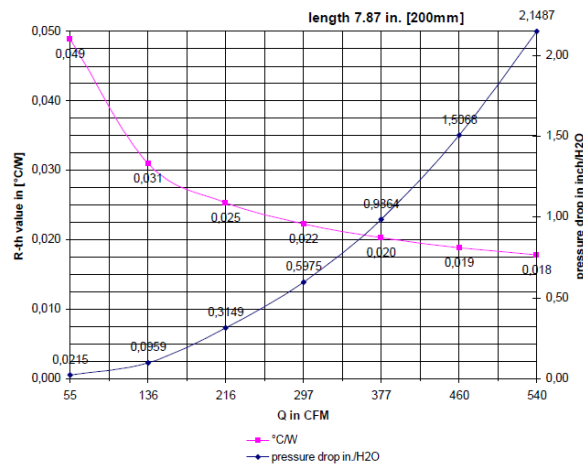
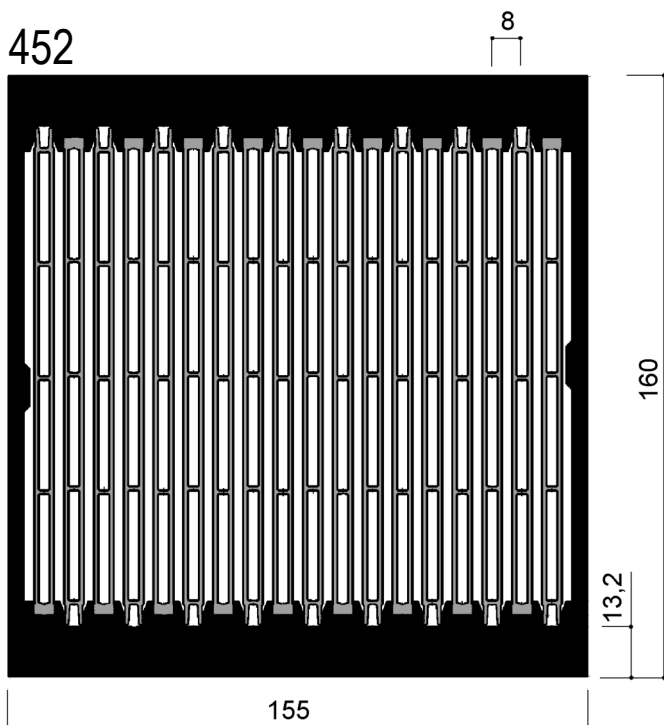

Resistenza termica (K/W) in ventilazione forzata

Lg. (mm)	100	200	300
R _{th} a 5m/s	0,046	0,031	0,025

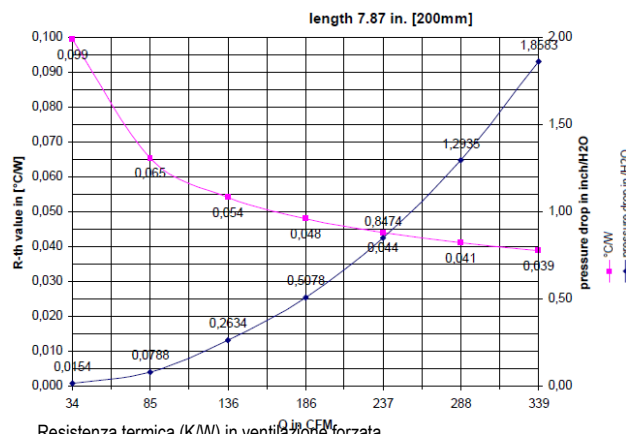
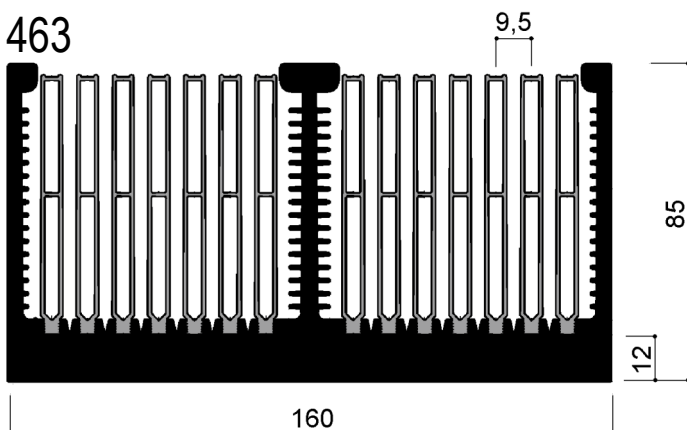

Resistenza termica (K/W) in ventilazione forzata

Lg. (mm)	100	200	300
R _{th} a 5m/s	0,082	0,065	0,05

I valori espressi dalle curve sono puramente indicativi

AGGIORNAMENTO CONTINUO - ED. DEL 09-2022

-RIPRODUZIONE VIETATA-



DISSIPATORI AD ALTO RENDIMENTO



DISEGNI META' DEL VERO (1:2)- SCALE 1:2



FOTO DI ESEMPIO: TAGLIO A MISURA DISSIPATORI AD ALTO RENDIMENTO DI GROSSE DIMENSIONI

Via Newton, n.12
20016 Pero (Milano - Italy)
Tel. +39 02 3535955 r.a. Fax. +39 02 3539929
E-Mail: info@omar-alluminio.it

Cataloghi Online: www.omar-alluminio.it
www.omar-alluminio.com
PROFILATI ALLUMINIO A DISEGNO / STANDARD / SPECIALI / E PER:
ELETTRONICA / LED / FOTOVOLTAICO / AUTOMAZIONE ROBOTICA / PNEUMATICA / AUTOMOTIVE

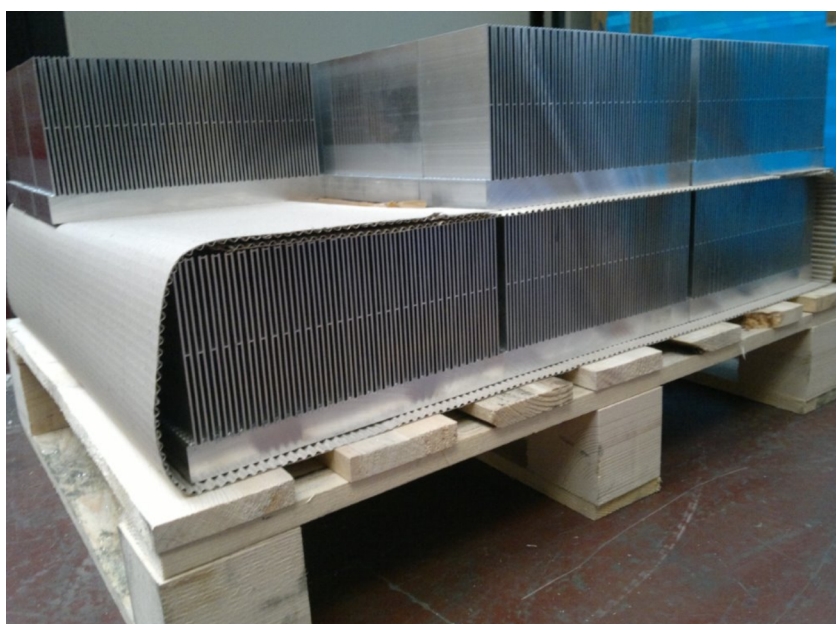
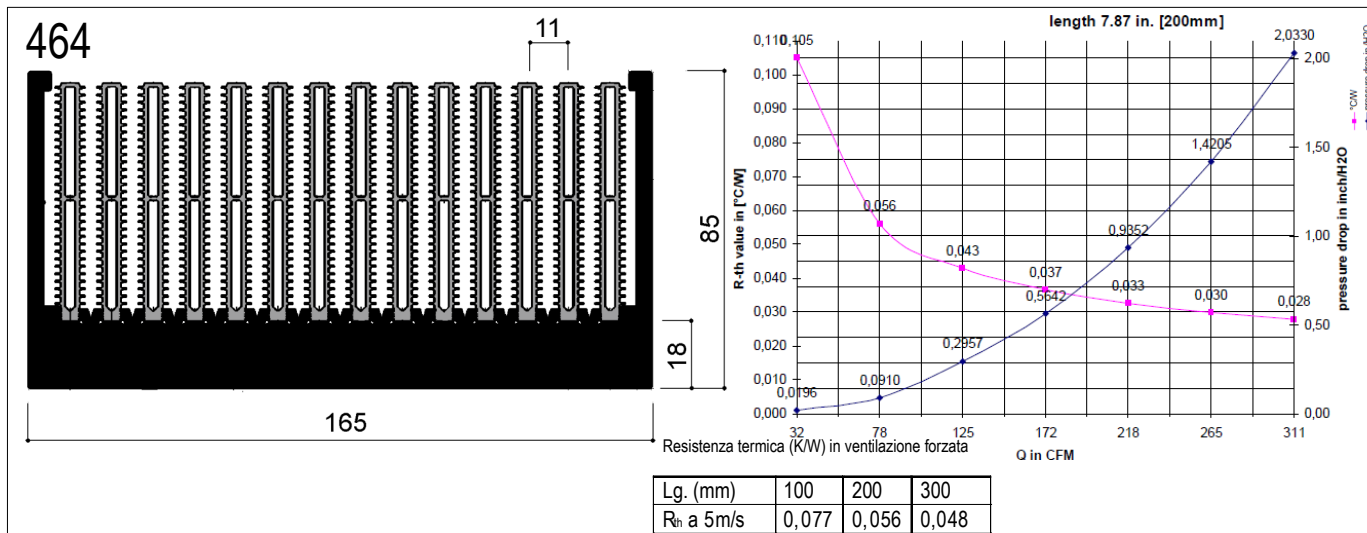
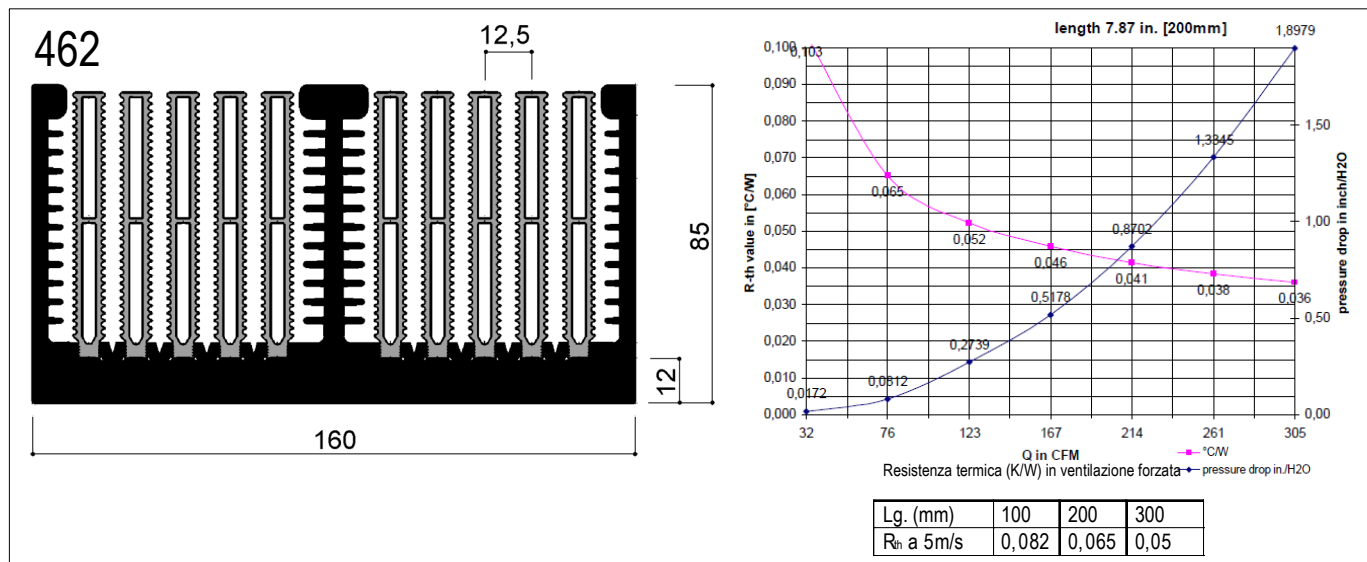

DISSIPATORI AD ALTO RENDIMENTO



DISEGNI META' DEL VERO (1:2)- SCALE 1:2

Via Newton, n.12
20016 Pero (Milano - Italy)
Tel. +39 02 3535955 r.a. Fax. +39 02 3539929
E. Mail: info@omar-alluminio.it

Cataloghi Online: www.omar-alluminio.it
www.omar-alluminio.com
PROFILATI ALLUMINIO A DISEGNO / STANDARD / SPECIALI / E PER:
ELETTRONICA / LED / FOTOVOLTAICO / AUTOMAZIONE ROBOTICA / PNEUMATICA / AUTOMOTIVE

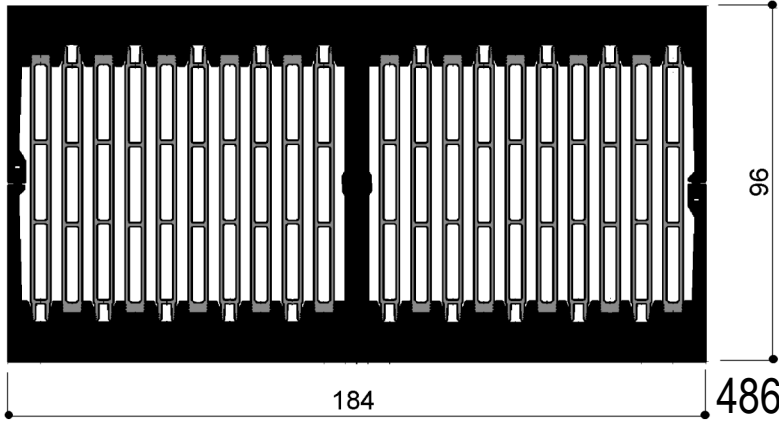

length 11.81 in. [300mm]

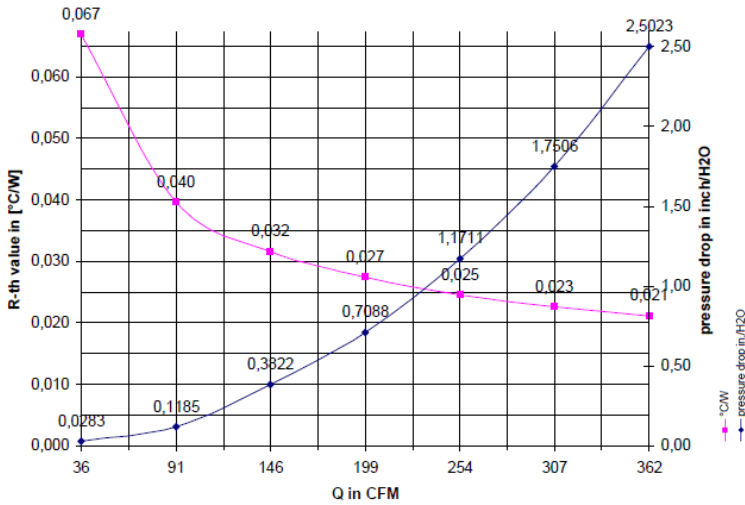

Resistenza termica (K/W) in ventilazione forzata

Lg. (mm)	100	200	300
R _{th} 5m/s	0,065	0,05	0,04



FOTO DI ESEMPIO: SI ESEGUONO OPERAZIONI DI TRANCIATURA SU PROFILI ESTRUSI IN ALLUMINIO

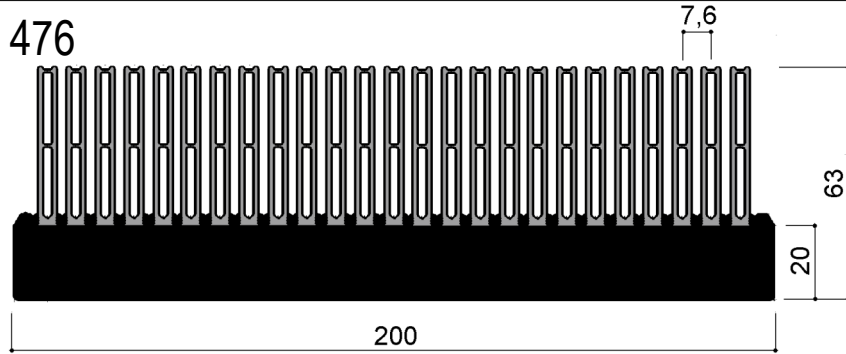

length 7.87 in. [200mm]

Resistenza termica (K/W) in ventilazione forzata

Lg. (mm)	100	200	300
R _{th} a 11 m/s	0,0617	0,042	0,034

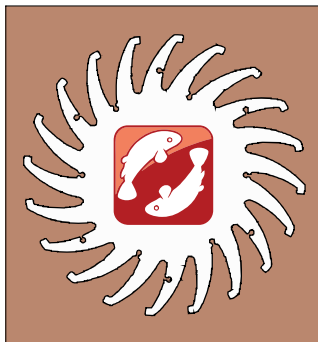
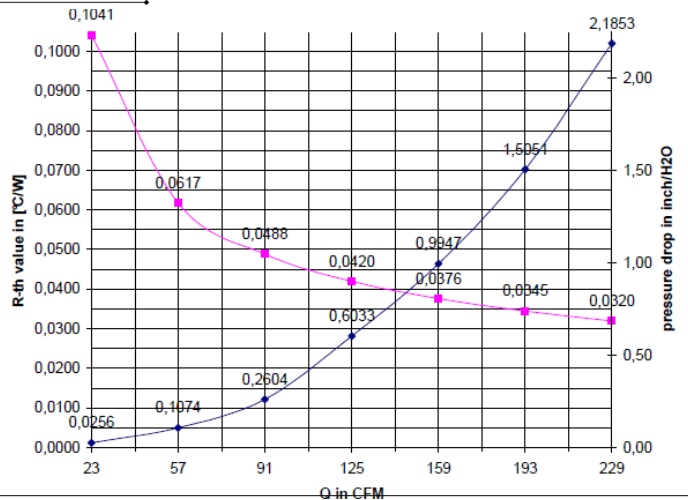

DISSIPATORI AD ALTO RENDIMENTO



DISEGNI META' DEL VERO (1:2)- SCALE 1:2

475

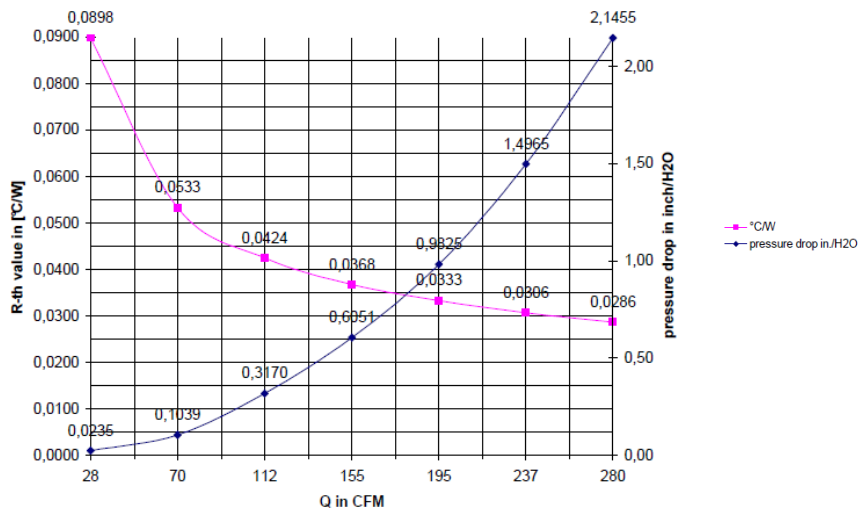
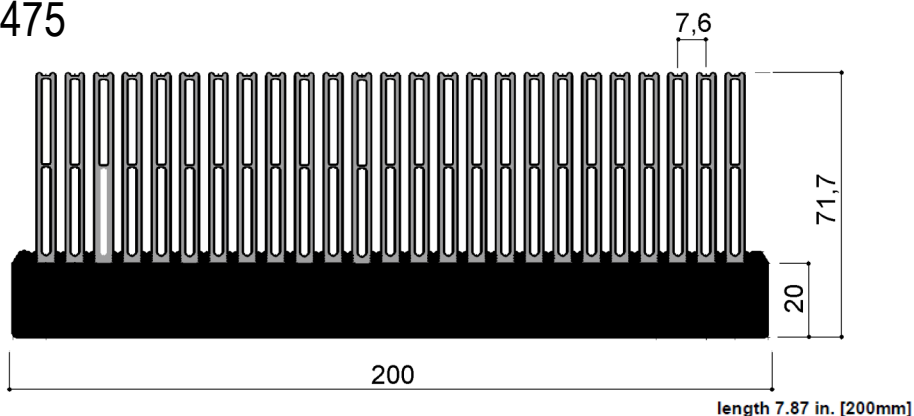

455



FOTO DI ESEMPIO: SI ESEGUONO LAVORAZIONI MECCANICHE SU PROFILI ESTRUSI IN ALLUMINIO

Via Newton, n.12
20016 Pero (Milano - Italy)
Tel. +39 02 3535955 r.a. Fax. +39 02 3539929
E-Mail: info@omar-alluminio.it

Cataloghi Online: www.omar-alluminio.it
www.omar-alluminio.com
PROFILATI ALLUMINIO A DISEGNO / STANDARD / SPECIALI / E PER:
ELETTRONICA / LED / FOTOVOLTAICO / AUTOMAZIONE ROBOTICA / PNEUMATICA / AUTOMOTIVE

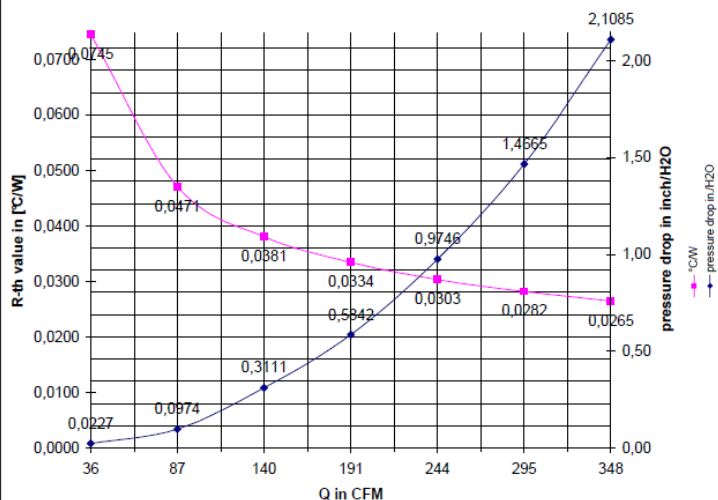
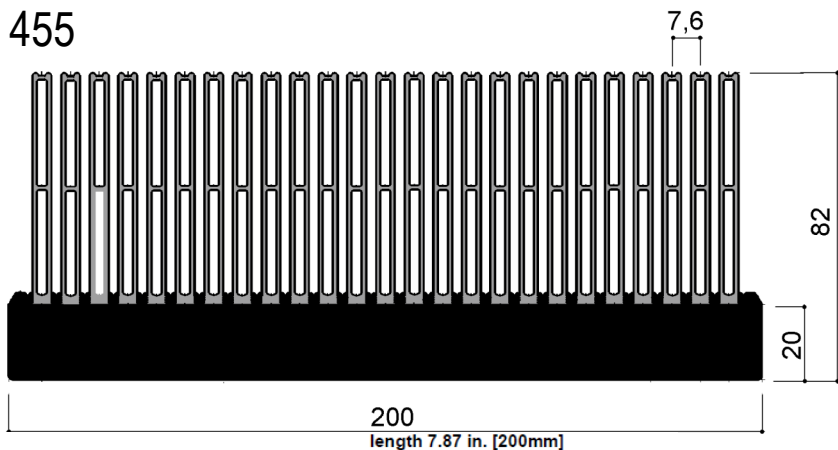

DISSIPATORI AD ALTO RENDIMENTO



DISEGNI META' DEL VERO (1:2)- SCALE 1:2

Via Newton, n.12
20016 Pero (Milano - Italy)
Tel. +39 02 3535955 r.a. Fax. +39 02 3539929
E. Mail: info@omar-alluminio.it

Cataloghi Online: www.omar-alluminio.it
www.omar-alluminio.com

PROFILATI ALLUMINIO A DISEGNO / STANDARD / SPECIALI / E PER:
ELETTRONICA / LED / FOTOVOLTAICO / AUTOMAZIONE ROBOTICA / PNEUMATICA / AUTOMOTIVE

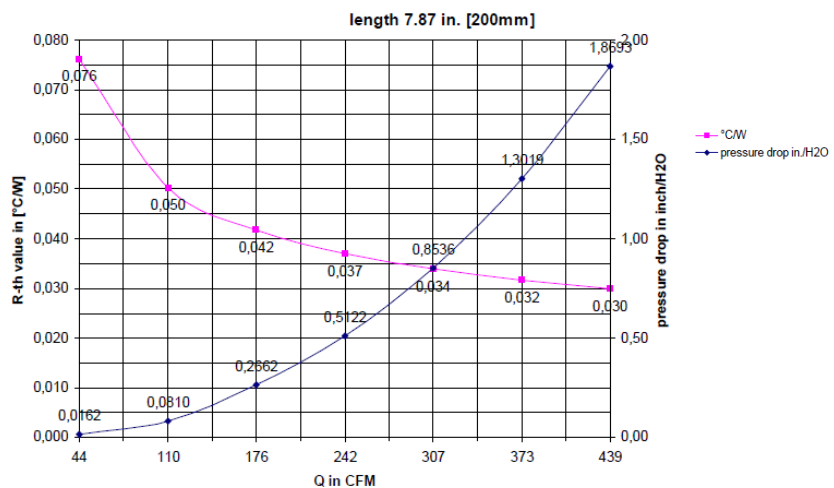
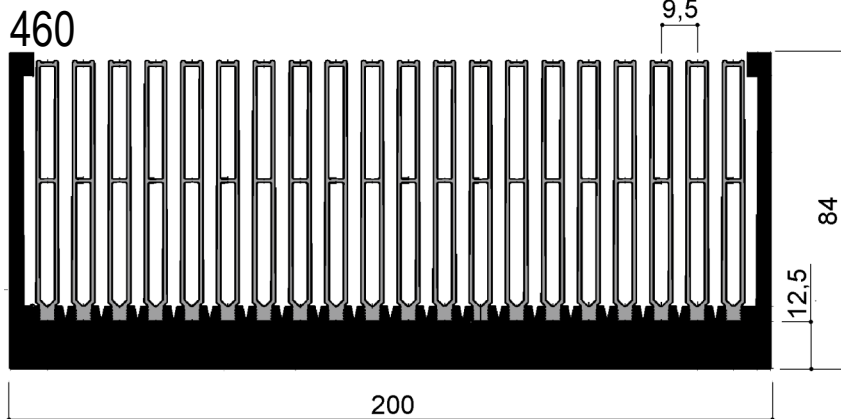
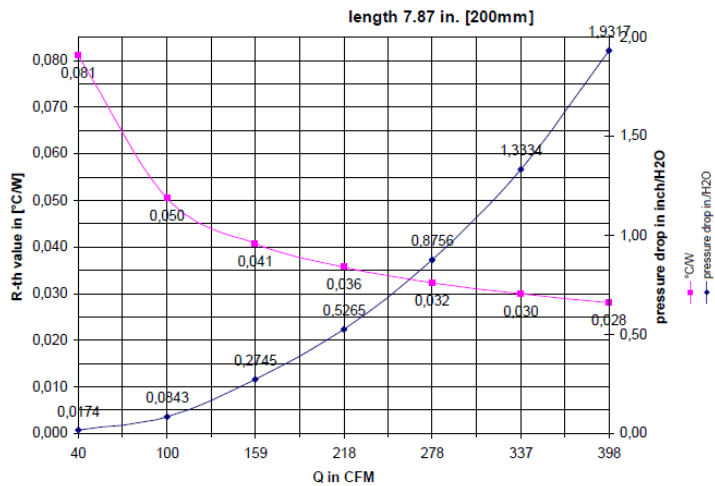
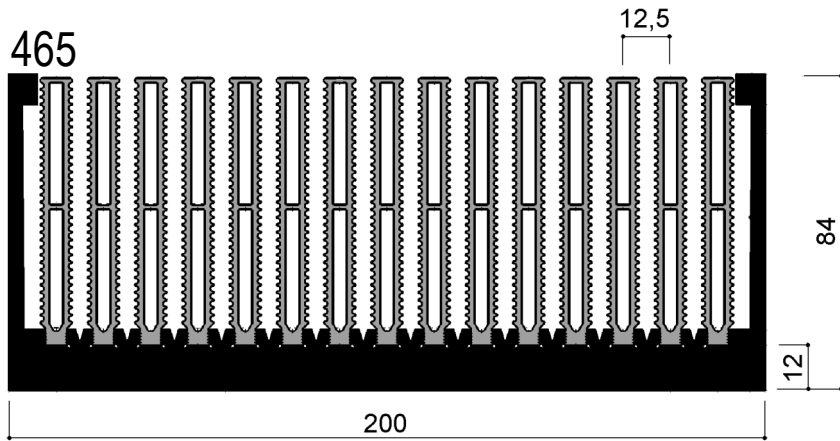

DISSIPATORI AD ALTO RENDIMENTO

DISEGNI META' DEL VERO (1:2)- SCALE 1:2

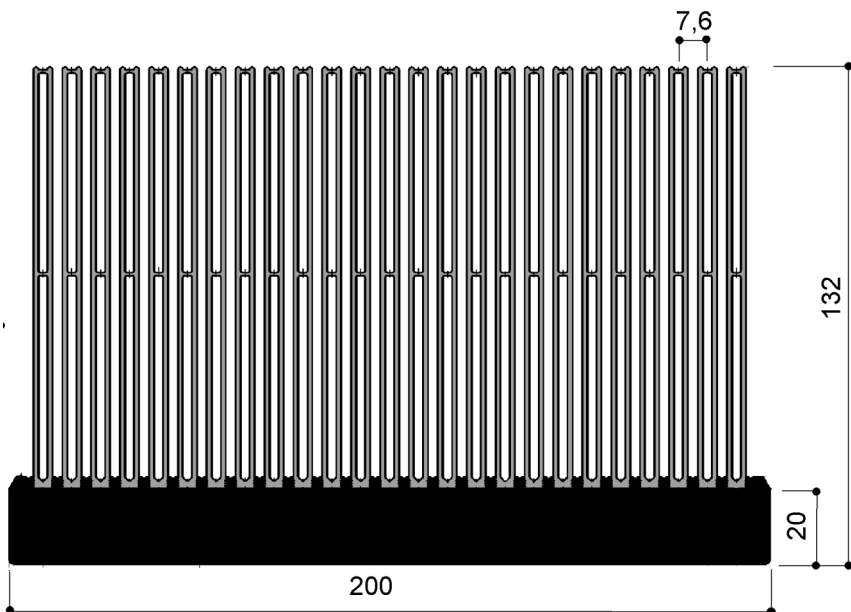

480

Resistenza termica (K/W) in ventilazione forzata

Lg. (mm)	200	300	400
Rth 5m/s	0,0414	0,0254	0,0193

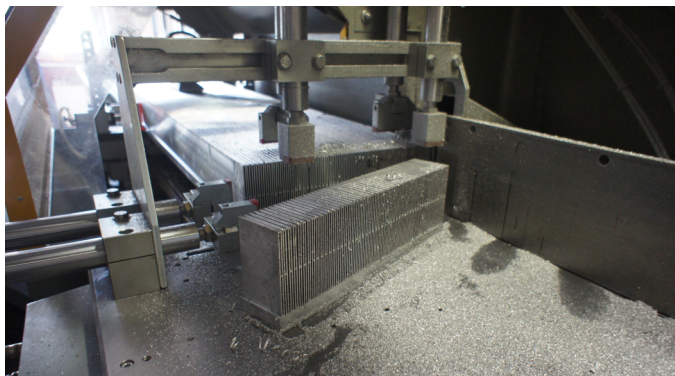
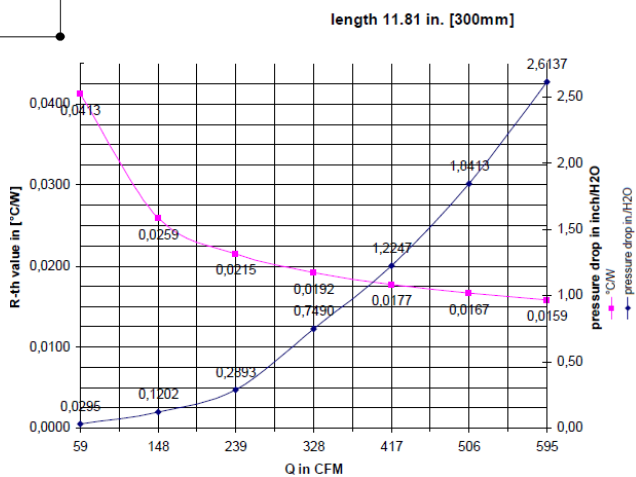

N.3 LINEE DI TAGLIO:SI ESEGUONO TAGLI SU PROFILI IN ALLUMINIO ANCHE DI GRANDI DIMENSIONI

Via Newton, n.12
20016 Pero (Milano - Italy)
Tel.+39 02 3535955 r.a. Fax.+39 02 3539929
E-Mail: info@omar-alluminio.it

Cataloghi Online: www.omar-alluminio.it
www.omar-alluminio.com
PROFILATI ALLUMINIO A DISEGNO / STANDARD / SPECIALI / E PER:
ELETTRONICA / LED / FOTOVOLTAICO / AUTOMAZIONE ROBOTICA / PNEUMATICA / AUTOMOTIVE



DISSIPATORI AD ALTO RENDIMENTO

DISEGNI META' DEL VERO (1:2)- SCALE 1:2

Via Newton, n.12
20016 Pero (Milano - Italy)
Tel. +39 02 3535955 r.a. Fax. +39 02 3539929
E. Mail: info@omar-alluminio.it

Cataloghi Online: www.omar-alluminio.it
www.omar-alluminio.com

PROFILATI ALLUMINIO A DISEGNO / STANDARD / SPECIALI / E PER:
ELETTRONICA / LED / FOTOVOLTAICO / AUTOMAZIONE ROBOTICA / PNEUMATICA / AUTOMOTIVE

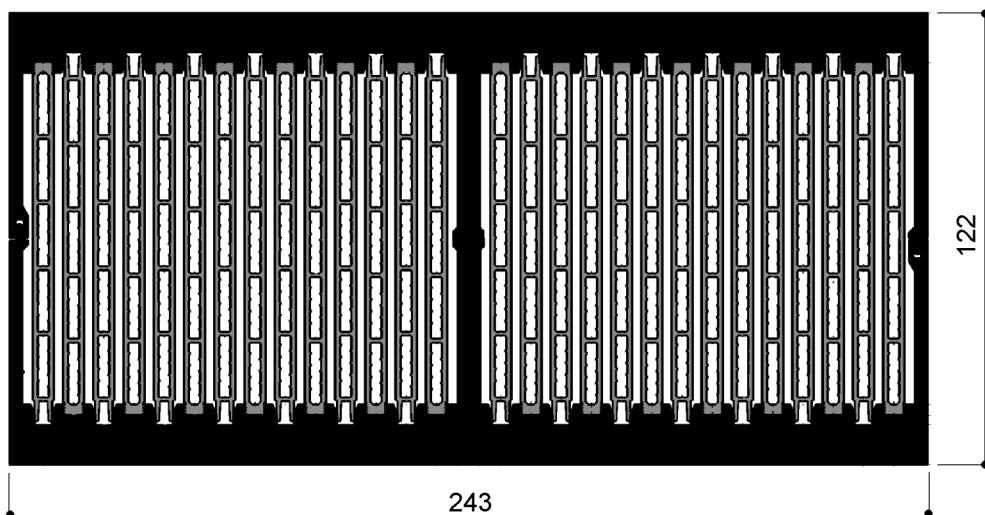

487

length 11.81 in. [300mm]

Resistenza termica (K/W) in ventilazione forzata

Lg. (mm)	100	200	300
Rth 5m/s	0,041	0,034	0,026

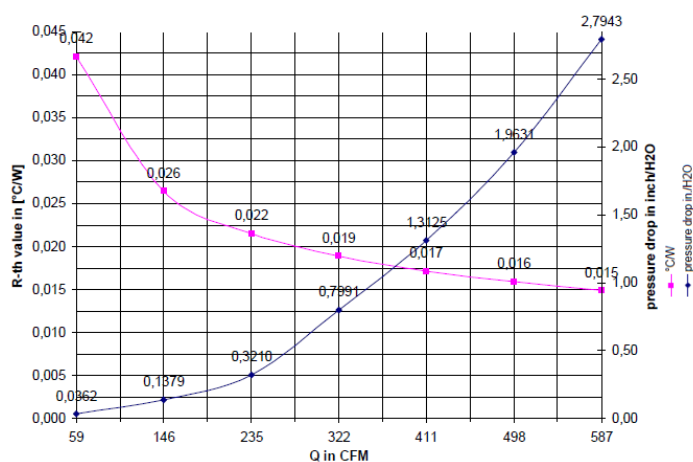

484

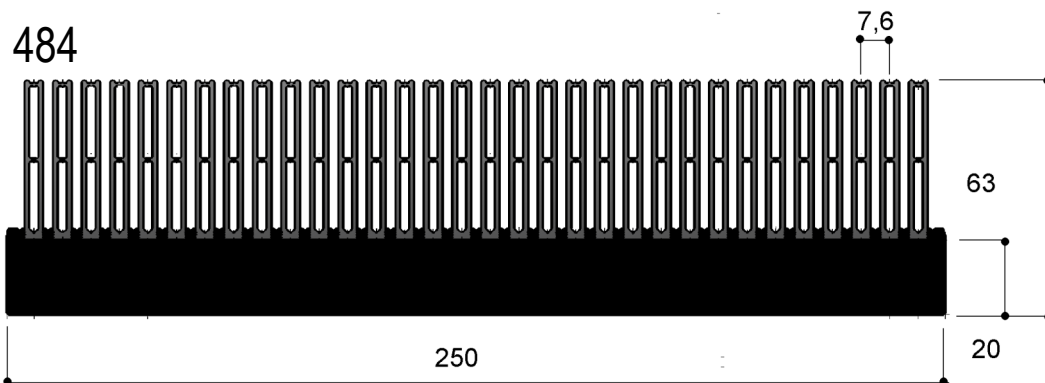

length 11.81 in. [300mm]

Resistenza termica (K/W) in ventilazione forzata

Lg. (mm)	100	200	300
Rth 11m/s	0,0480	0,0328	0,0265

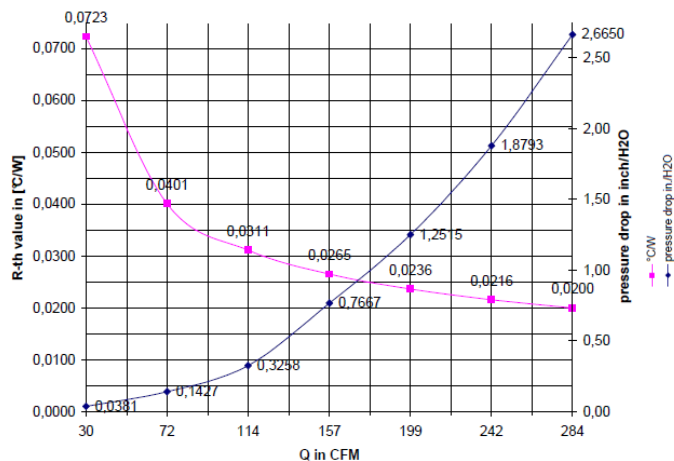

DISSIPATORI AD ALTO RENDIMENTO



DISEGNI META' DEL VERO (1:2) - SCALE 1:2

483

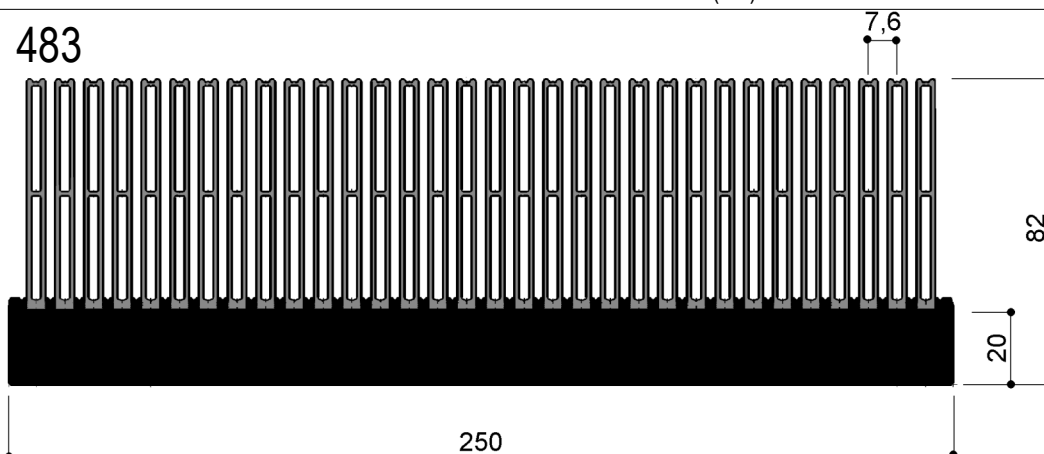

Resistenza termica (K/W) in ventilazione forzata

Lg. (mm)	100	200	300
Rm 11m/s	0,0400	0,0261	0,0207

length 11.81 in. [300mm]

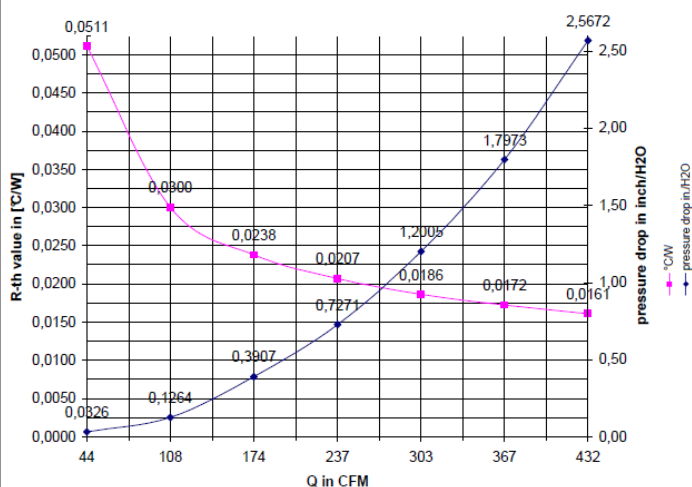

489

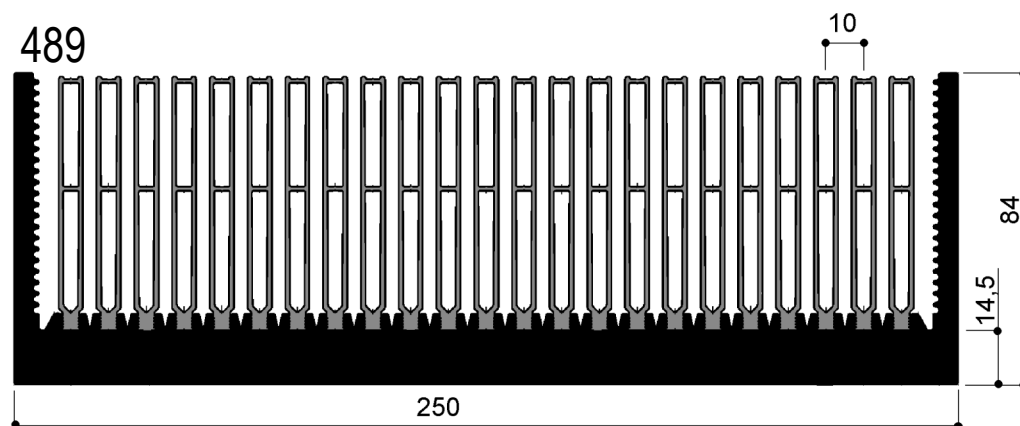

Resistenza termica (K/W) in ventilazione forzata

Lg. (mm)	100	200	300	400
Rm 5/s	0,0663	0,0438	0,0349	0,0300

length 15.74 in. [400mm]

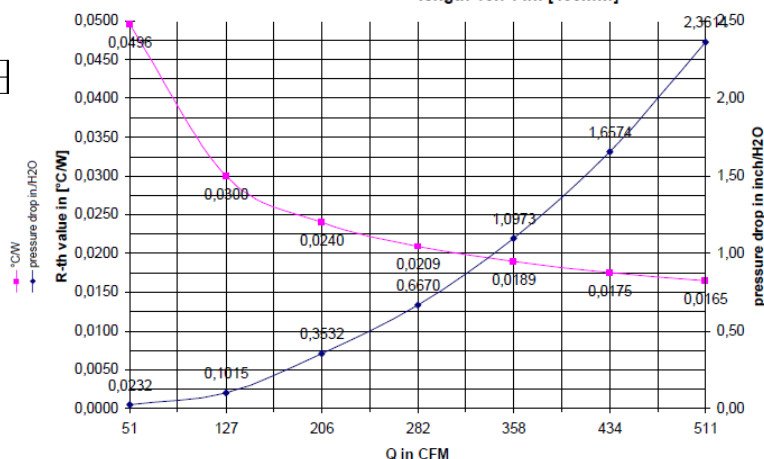

Via Newton, n.12
20016 Pero (Milano - Italy)
Tel. +39 02 3535955 r.a. Fax. +39 02 3539929
E-Mail: info@omar-alluminio.it

Cataloghi Online: www.omar-alluminio.it
www.omar-alluminio.com

PROFILATI ALLUMINIO A DISEGNO / STANDARD / SPECIALI / E PER:
ELETTRONICA / LED / FOTOVOLTAICO / AUTOMAZIONE ROBOTICA / PNEUMATICA / AUTOMOTIVE



DISSIPATORI AD ALTO RENDIMENTO



Via Newton, n.12
20016 Pero (Milano - Italy)
Tel. +39 02 3535955 r.a. Fax. +39 02 3539929
E-Mail: info@omar-alluminio.it

Cataloghi Online: www.omar-alluminio.it
www.omar-alluminio.com

PROFILATI ALLUMINIO A DISEGNO / STANDARD / SPECIALI / E PER:
ELETTRONICA / LED / FOTOVOLTAICO / AUTOMAZIONE ROBOTICA / PNEUMATICA / AUTOMOTIVE



DISEGNI META' DEL VERO (1:2)- SCALE 1:2

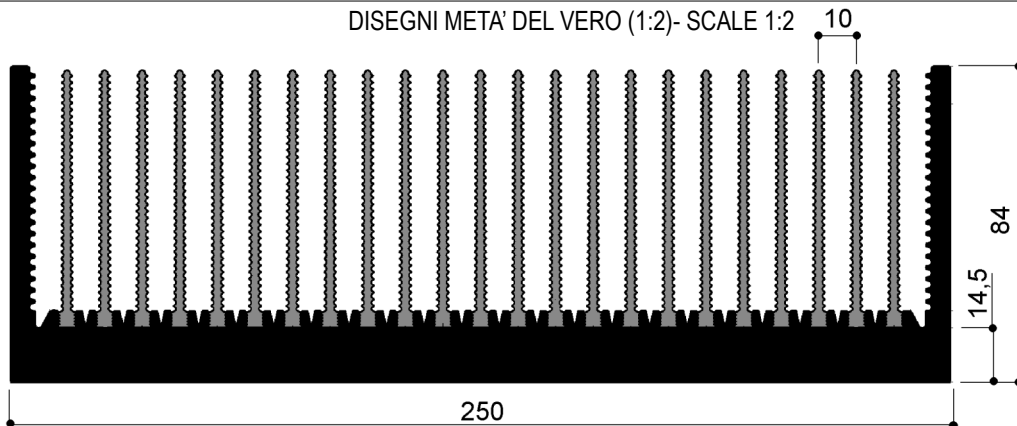

492

Resistenza termica (K/W) in ventilazione forzata

Lg. (mm)	100	200	300	400
Rth5/s	0,0963	0,0644	0,0516	0,0437

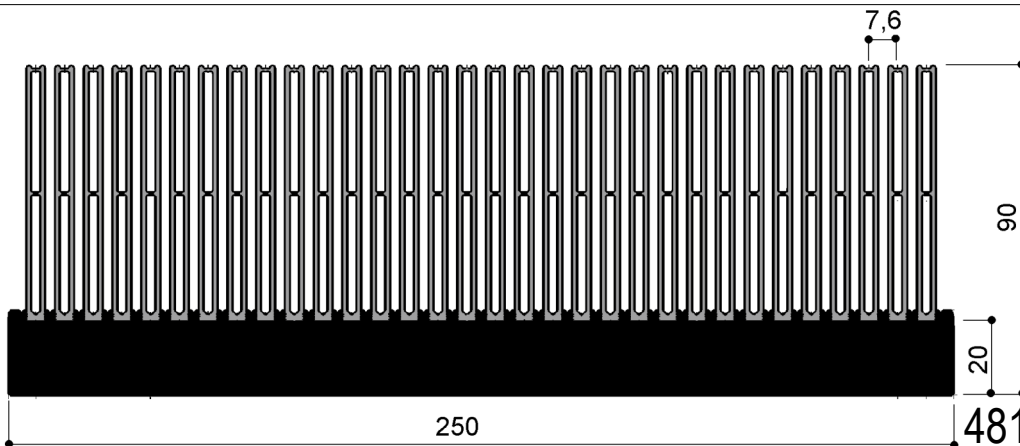
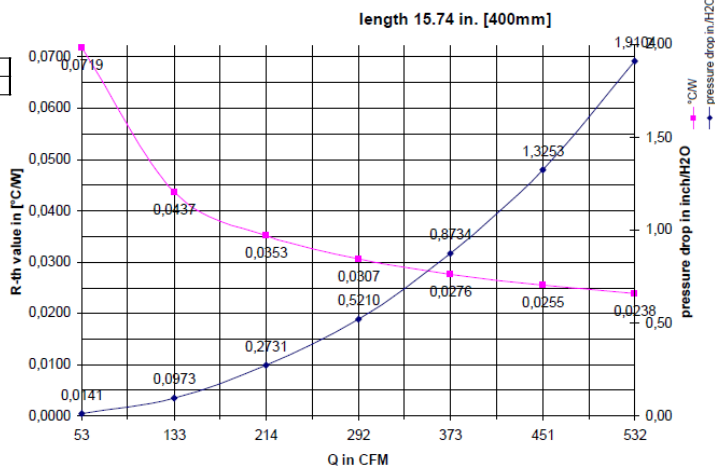

Resistenza termica (K/W) in ventilazione forzata

Lg. (mm)	100	200	300
Rth11m/s	0,0370	0,0239	0,0188



FOTO DI ESEMPIO: DISSIPATORI "FLOWER" A STOCK IN PRONTA CONSEGNA

DISSIPATORI AD ALTO RENDIMENTO



DISEGNI META' DEL VERO (1:2)- SCALE 1:2

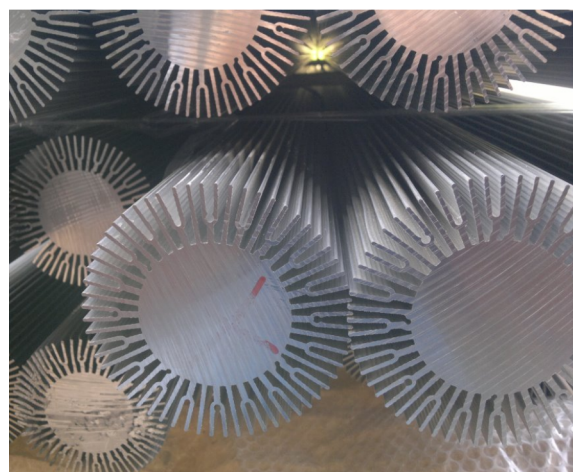
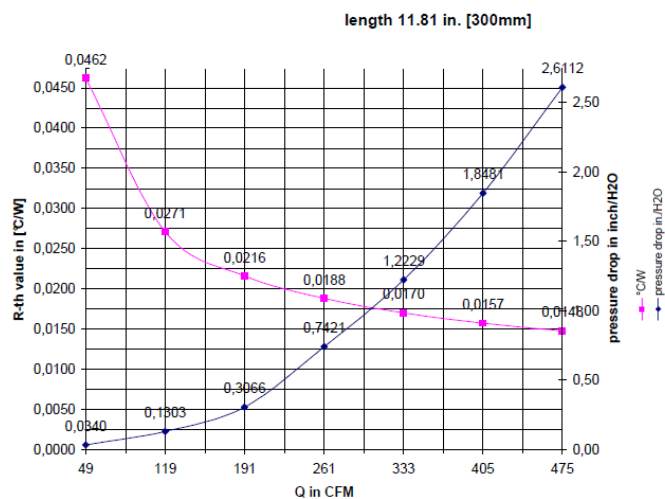
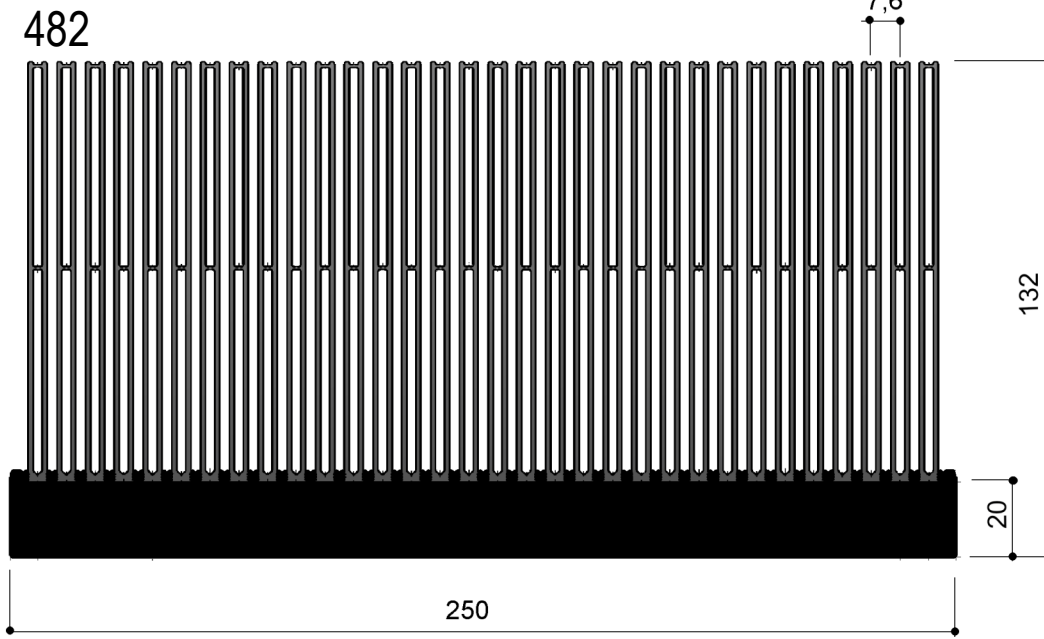

Resistenza termica (K/W) in ventilazione forzata

Lg. (mm)	100	200	300
R _{th} 11m/s	0,0324	0,0198	0,0151

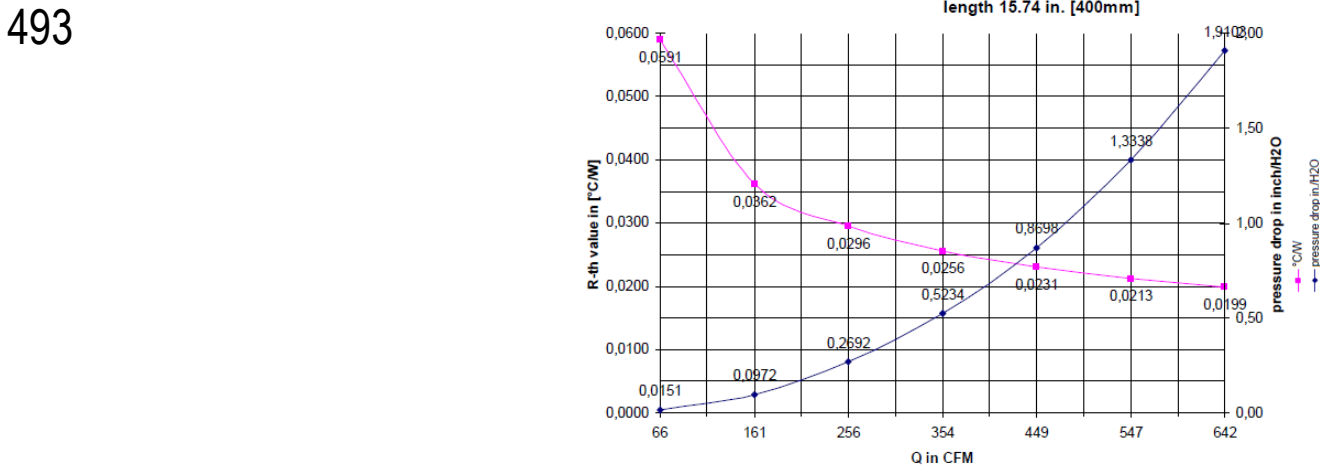
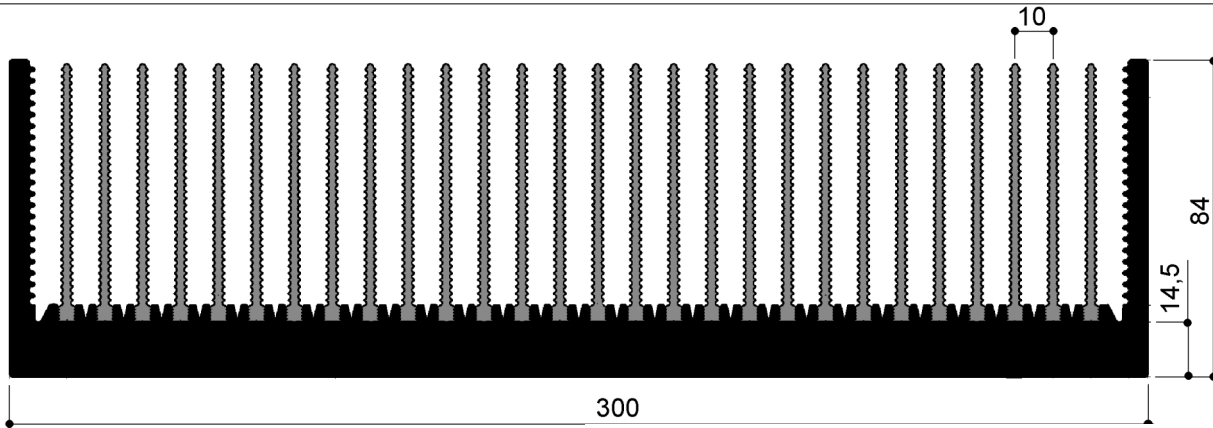
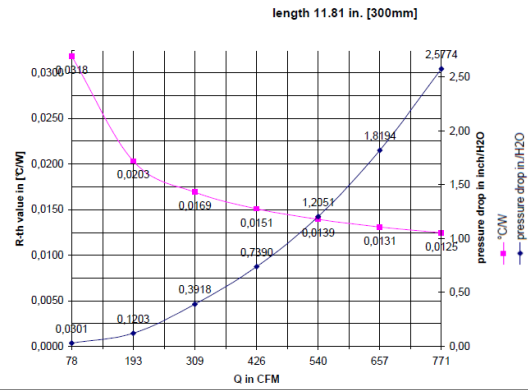

Cataloghi Online: www.omar-alluminio.it
www.omar-alluminio.com

PROFILATI ALLUMINIO A DISEGNO / STANDARD / SPECIALI / E PER:
 ELETTRONICA / LED / FOTOVOLTAICO / AUTOMAZIONE ROBOTICA / PNEUMATICA / AUTOMOTIVE



Via Newton, n.12
 20016 Pero (Milano - Italy)
 Tel. +39 02 3535955 r.a. Fax. +39 02 3539929
 E-Mail: info@omar-alluminio.it

DISSIPATORI AD ALTO RENDIMENTO



Via Newton, n.12
20016 Pero (Milano - Italy)
Tel. +39 02 3535955 r.a. Fax. +39 02 3539929
E.Mail: info@omar-alluminio.it

Cataloghi Online: www.omar-alluminio.it
www.omar-alluminio.com

PROFILATI ALLUMINIO A DISEGNO / STANDARD / SPECIALI / E PER:
ELETTRONICA / LED / FOTOVOLTAICO / AUTOMAZIONE ROBOTICA / PNEUMATICA / AUTOMOTIVE

DISEGNI FUORI SCALA

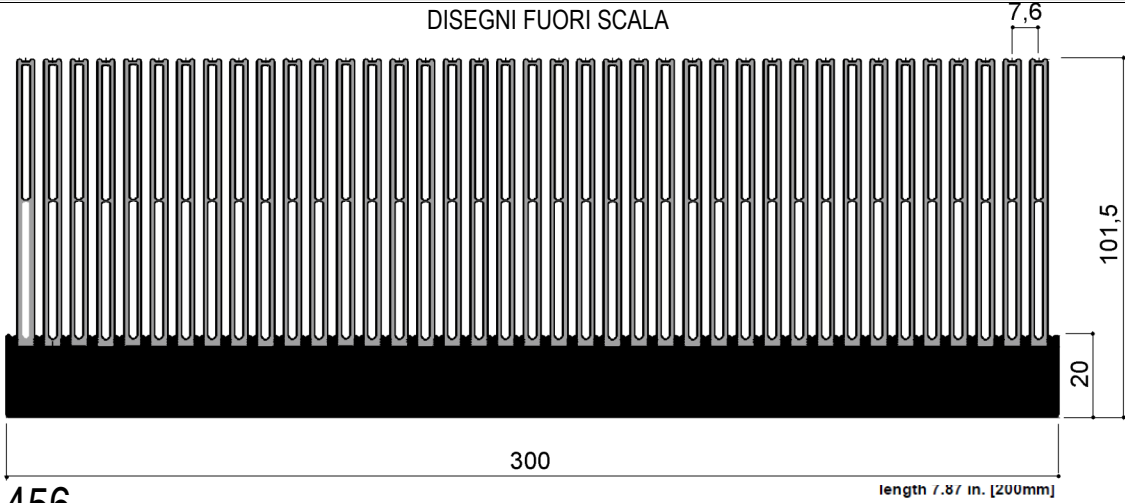

456

Resistenza termica (K/W) in ventilazione forzata

Lg. (mm)	100	200	300	400
R _{th} a 11 m/s	0,00284	0,0181	0,0141	0,119

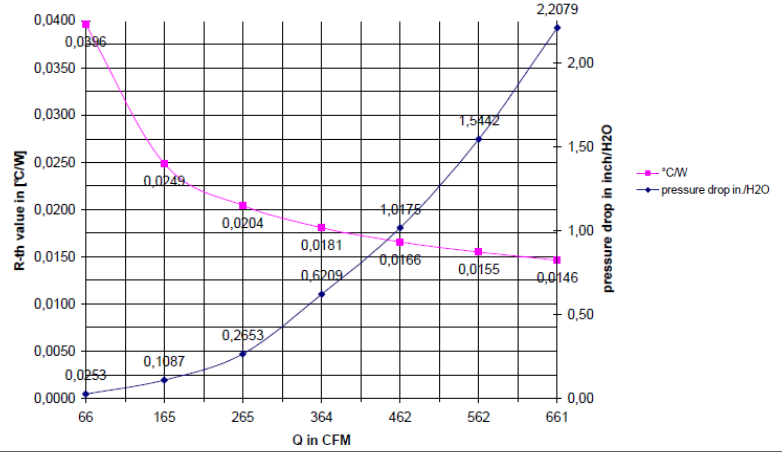

DISEGNI FUORI SCALA

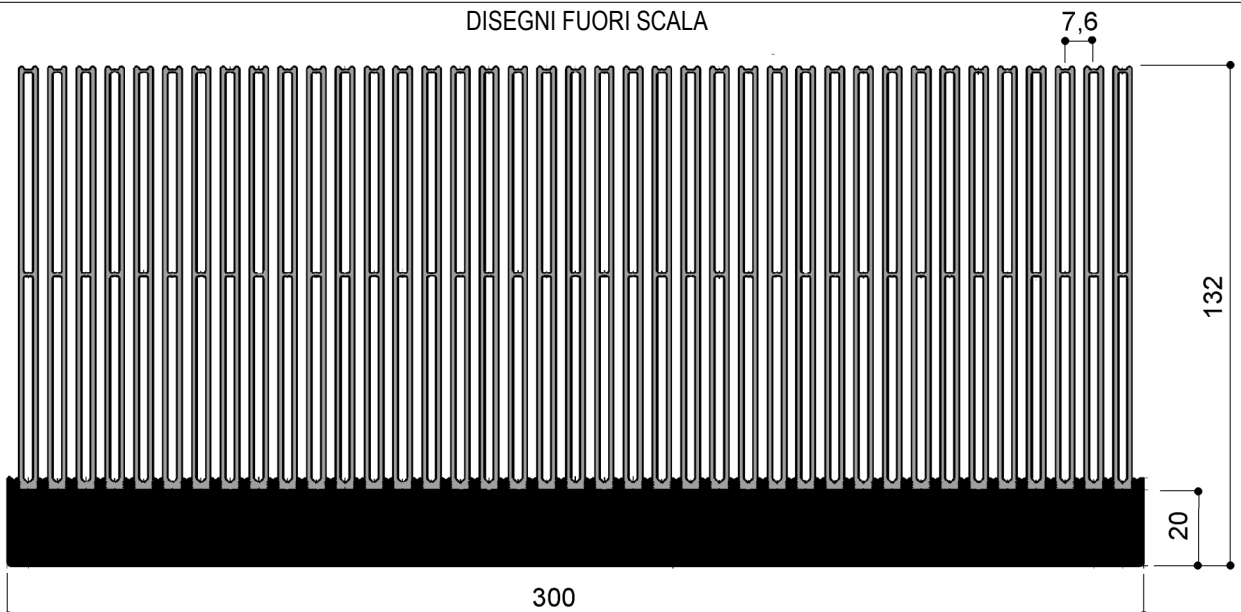

479

Resistenza termica (K/W) in ventilazione forzata

Lg. (mm)	200	300	400
R _{th} 5 m/s	0,0163	0,0124	0,0103

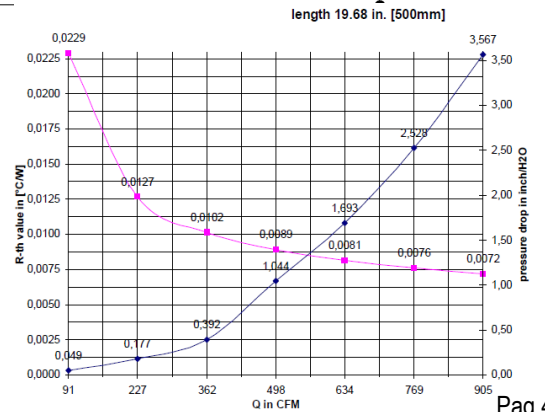

I valori espressi dalle curve sono puramente indicativi

AGGIORNAMENTO CONTINUO - ED. DEL 09-2022-RIPRODUZIONE VIETATA-



DISSIPATORI AD ALTO RENDIMENTO



DISEGNI FUORI SCALA

491

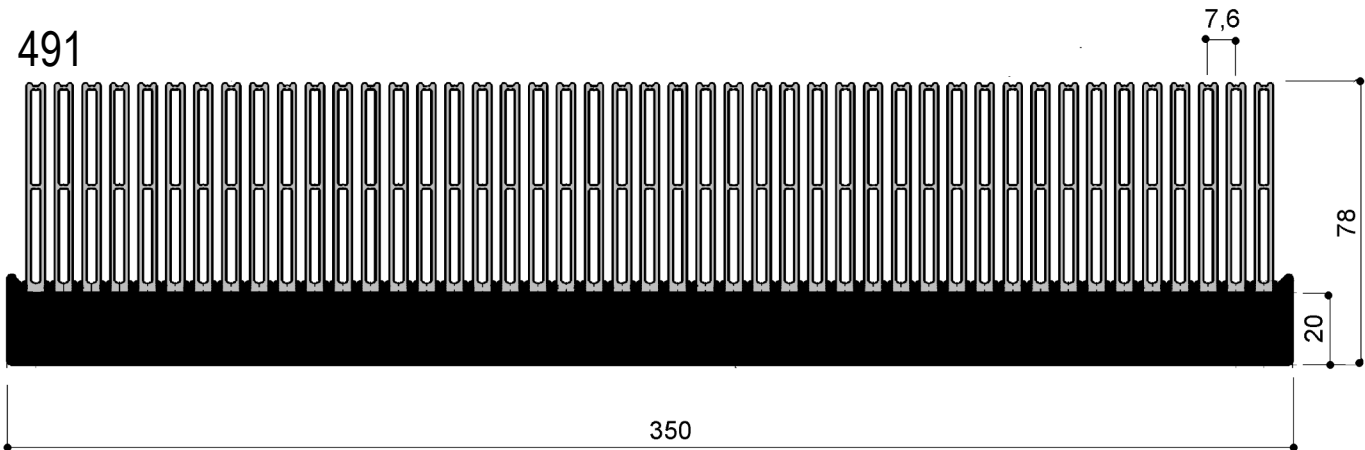

466



FOTO DI ESEMPIO: PROFILI IN ALLUMINIO CARCASSE DI MOTORI ELETTRICI TAGLIATI A MISURA STOCCATI SU PALLETT, IN PRONTA CONSEGNA

Via Newton, n.12
20016 Pero (Milano - Italy)
Tel. +39 02 3535955 r.a. Fax. +39 02 3539929
E-Mail: info@omar-alluminio.it

Cataloghi Online: www.omar-alluminio.it
www.omar-alluminio.com

PROFILATI ALLUMINIO

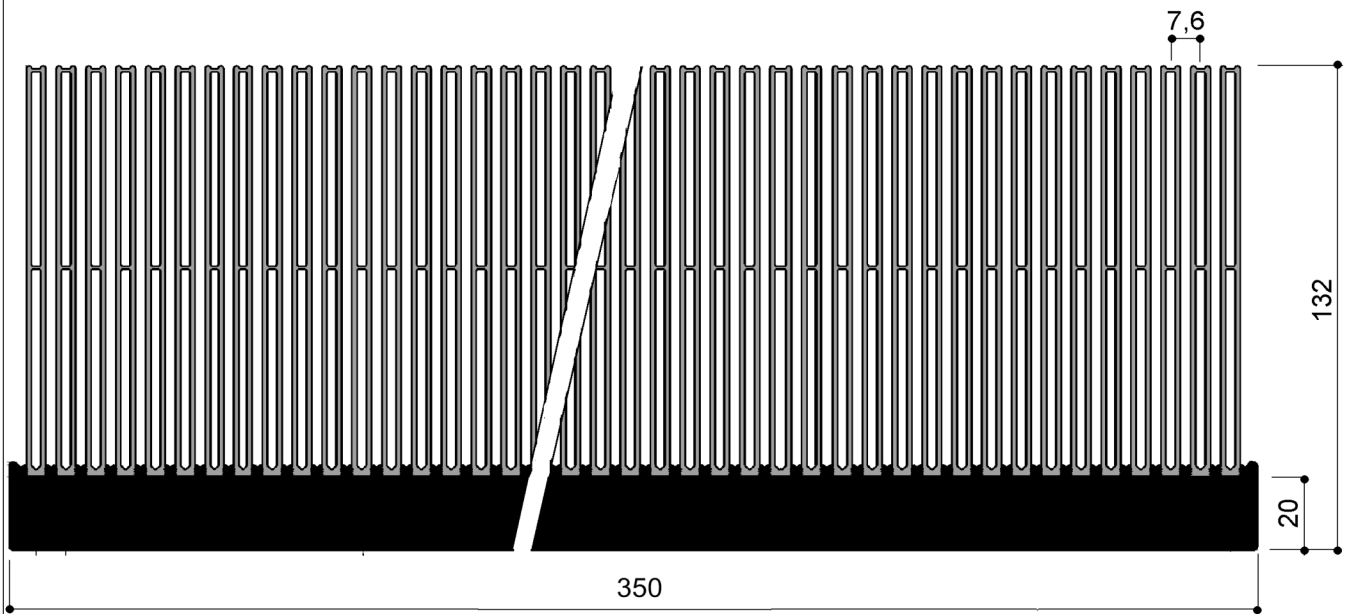
A DISEGNO / STANDARD / SPECIALI E LORO DERIVATI



DISSIPATORI AD ALTO RENDIMENTO



Via Newton, n.12
20016 Pero (Milano - Italy)
Tel. +39 02 3535955 r.a. Fax. +39 02 3539929
E. Mail: info@omar-alluminio.it

Cataloghi Online: www.omar-alluminio.it
www.omar-alluminio.com

PROFILATI ALLUMINIO A DISEGNO / STANDARD / SPECIALI / E PER:
ELETTRONICA / LED / FOTOVOLTAICO / AUTOMAZIONE ROBOTICA / PNEUMATICA / AUTOMOTIVE

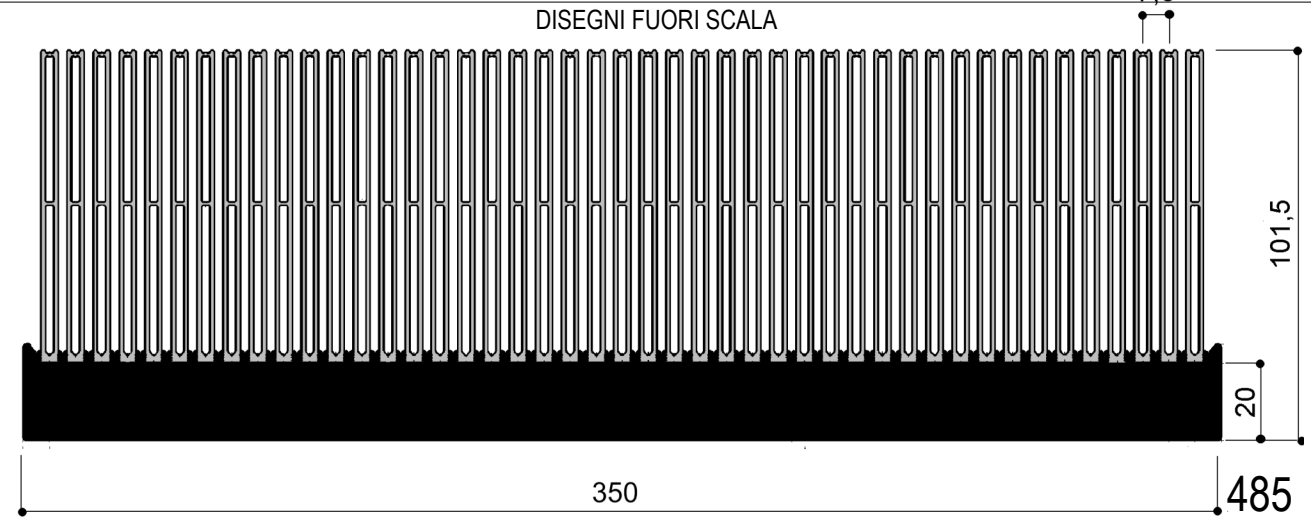

Resistenza termica (K/W) in ventilazione forzata

Lg. (mm)	200	300	400
Rth 11 m/s	0,0157	0,0122	0,0103



FOTO DI ESEMPIO: DISSIPATORI A VENTILAZIONE FORZATA PER 6 SCHEDE LED



471

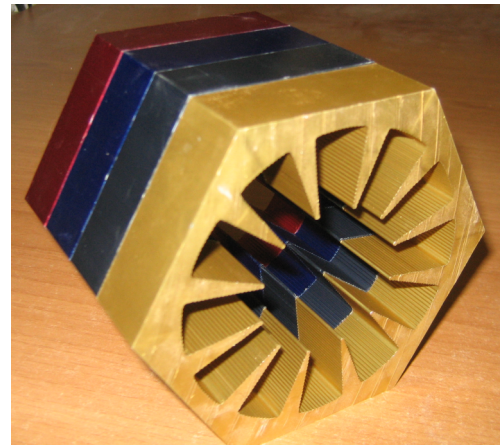
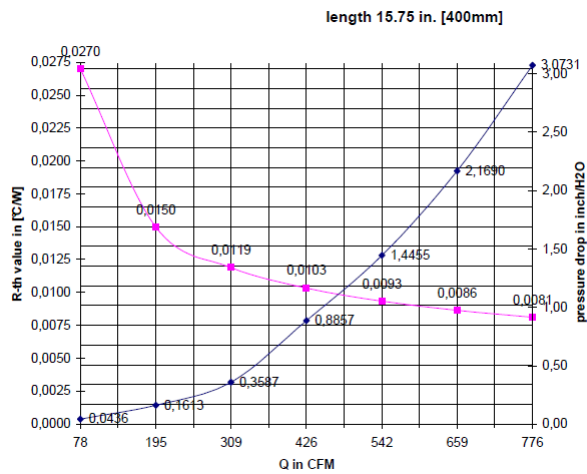
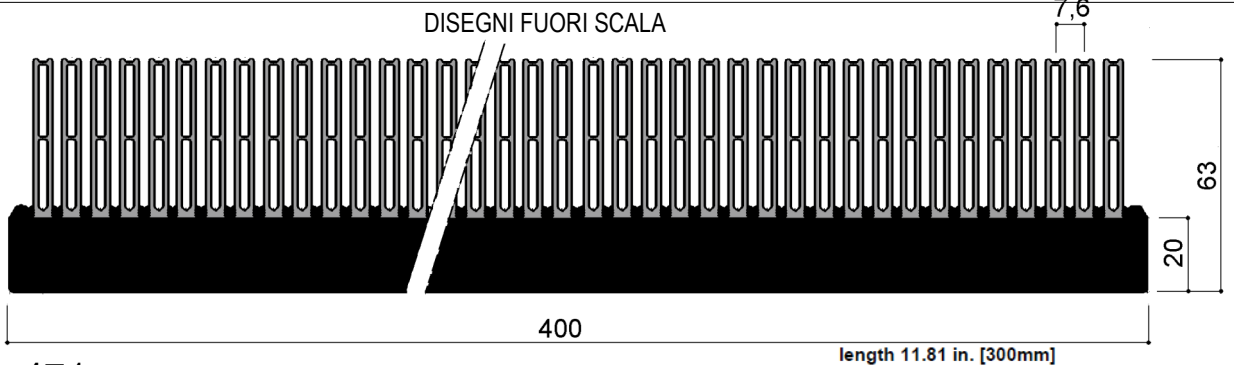
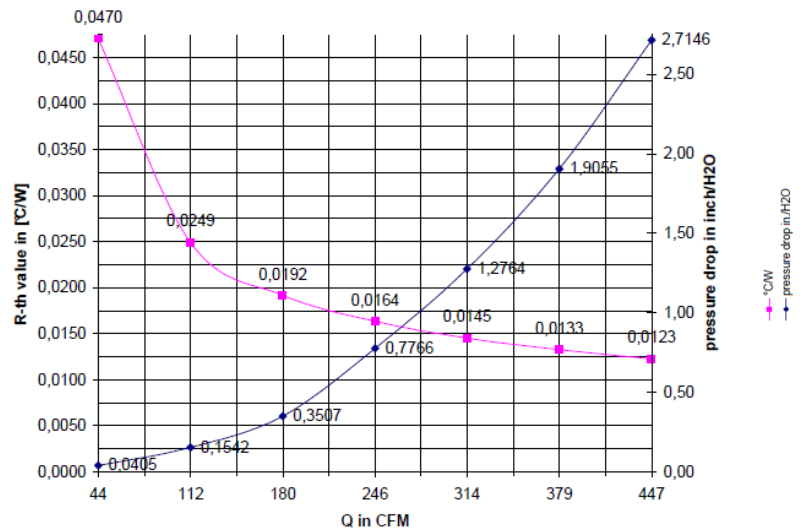

I valori espressi dalle curve sono puramente indicativi
AGGIORNAMENTO CONTINUO - ED. DEL 09-2022
-RIPRODUZIONE VIETATA-



DISSIPATORI AD ALTO RENDIMENTO



DISEGNI META' DEL VERO (1:2)- SCALE 1:2

457

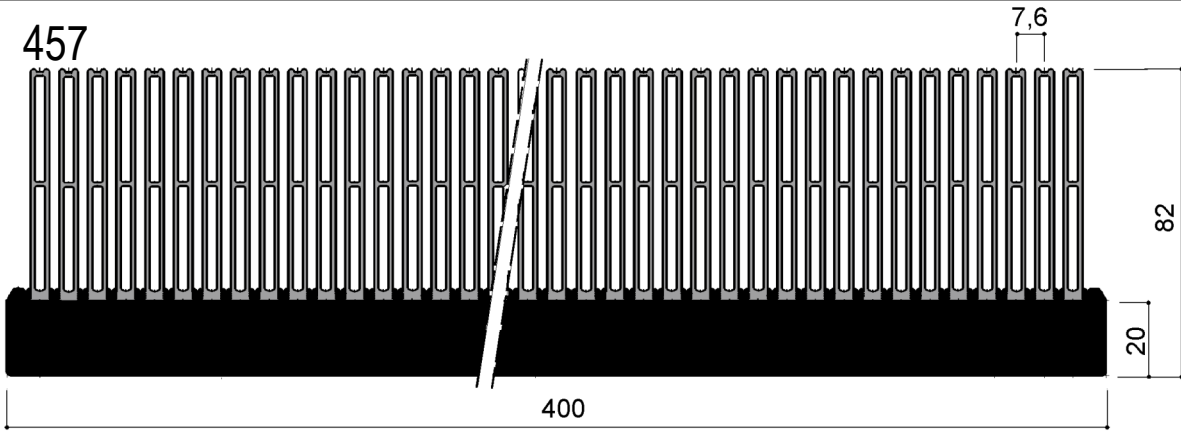

Resistenza termica (K/W) in ventilazione forzata

Lg. (mm)	200	300	400	500
R _{th} a 11m/s	0,00161	0,0128	0,0109	0,0097

length 11.81 in. [300mm]



FOTO DI ESEMPIO: TAGLIO A MISURA DI DISSIPATORI "FLOWER" ANCHE DI GROSSE DIMENSIONI

494

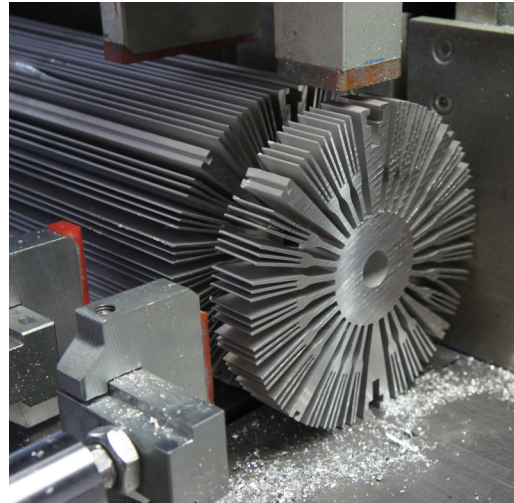
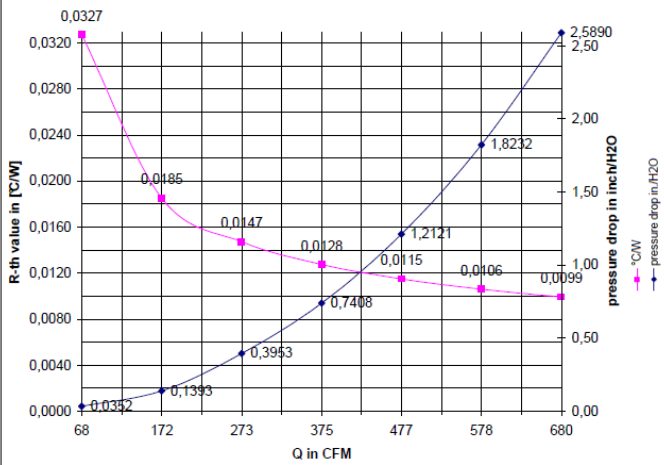
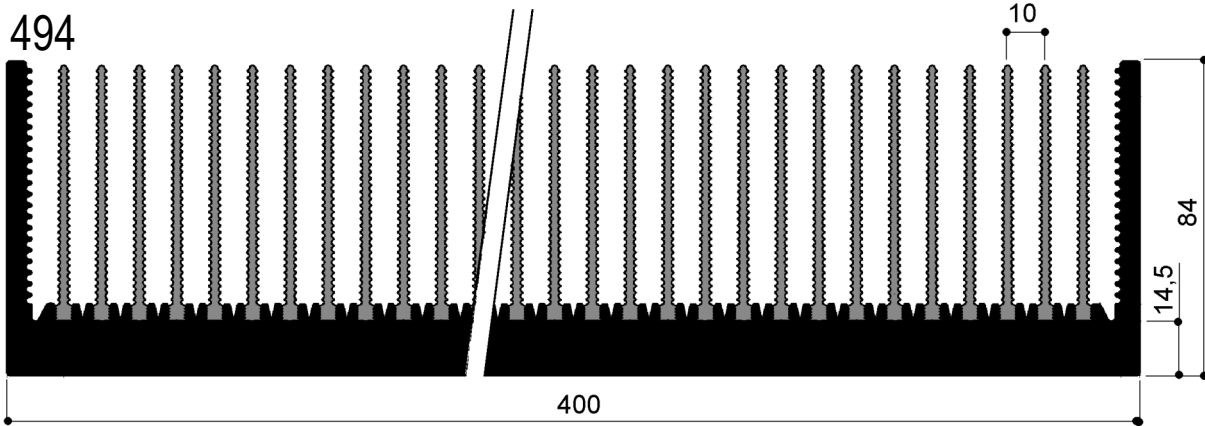

Resistenza termica (K/W) in ventilazione forzata

Lg. (mm)	100	200	300	400	500
R _{th} 5 m/s	0,0594	0,0898	0,0839	0,0270	0,0229

length 19.68 in. [500mm]

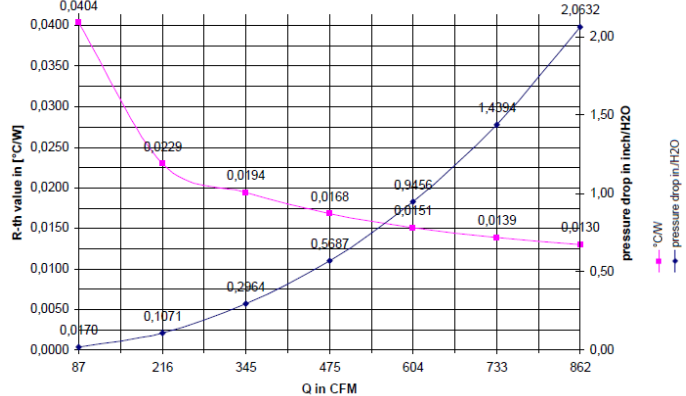

I valori espressi dalle curve sono puramente indicativi

-RIPRODUZIONE VIETATA- AGGIORNAMENTO CONTINUO - ED. DEL 09-2022

Cataloghi Online: www.omar-alluminio.it

www.omar-alluminio.com

PROFILATI ALLUMINIO

A DISEGNO / STANDARD / SPECIALI E LORO DERIVATI



Via Newton, n.12

20016 Pero (Milano - Italy)

Tel. +39 02 3535955 r.a. Fax. +39 02 3539929

E-Mail: info@omar-alluminio.it

DISSIPATORI AD ALTO RENDIMENTO



DISEGNI META' DEL VERO (1:2)- SCALE 1:2

Via Newton, n.12
20016 Pero (Milano - Italy)
Tel. +39 02 3535955 r.a. Fax. +39 02 3539929
E. Mail: info@omar-alluminio.it

Cataloghi Online: www.omar-alluminio.it
www.omar-alluminio.com

PROFILATI ALLUMINIO A DISEGNO / STANDARD / SPECIALI / E PER:
ELETTRONICA / LED / FOTOVOLTAICO / AUTOMAZIONE ROBOTICA / PNEUMATICA / AUTOMOTIVE

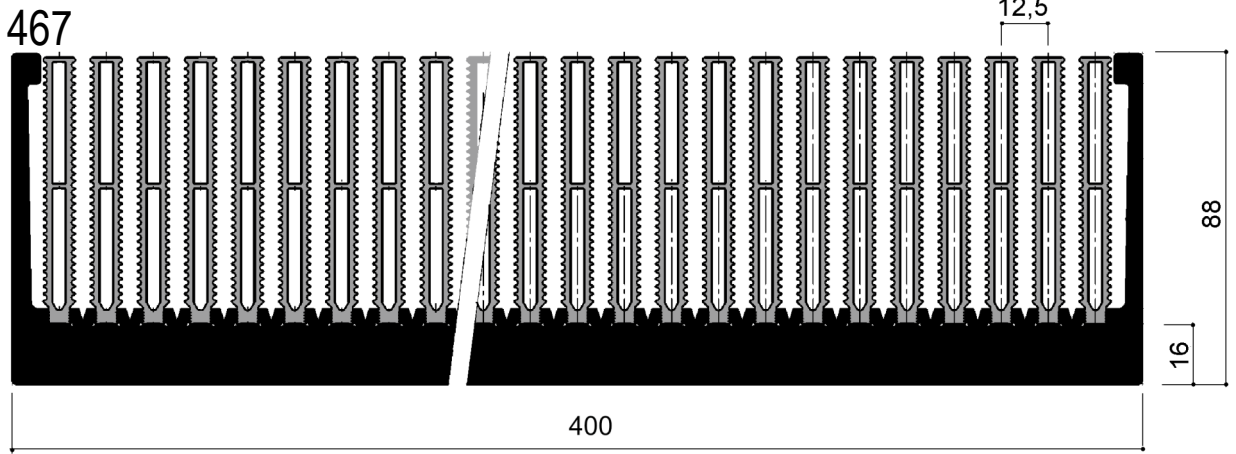

Resistenza termica (K/W) in ventilazione forzata

Lg. (mm)	100	200	300
R _{th} a 5m/s	0,036	0,026	0,019

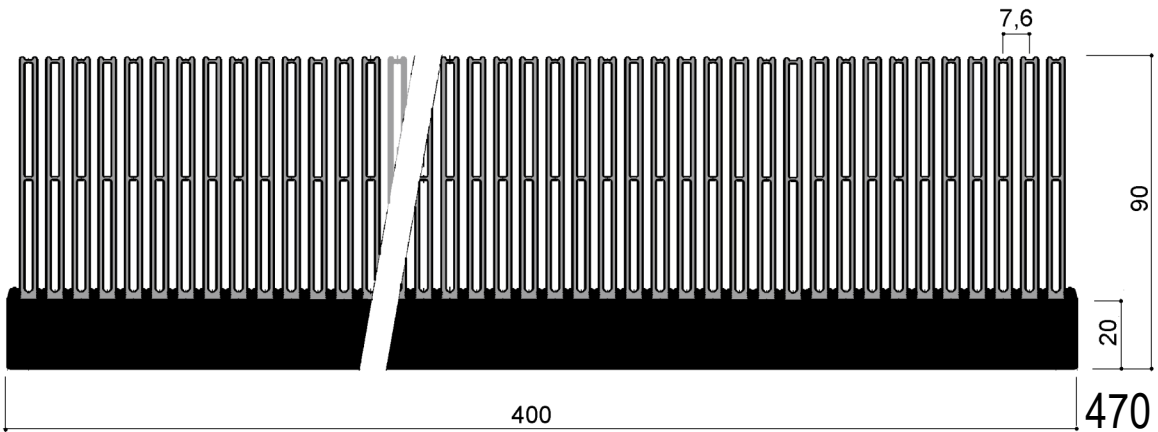
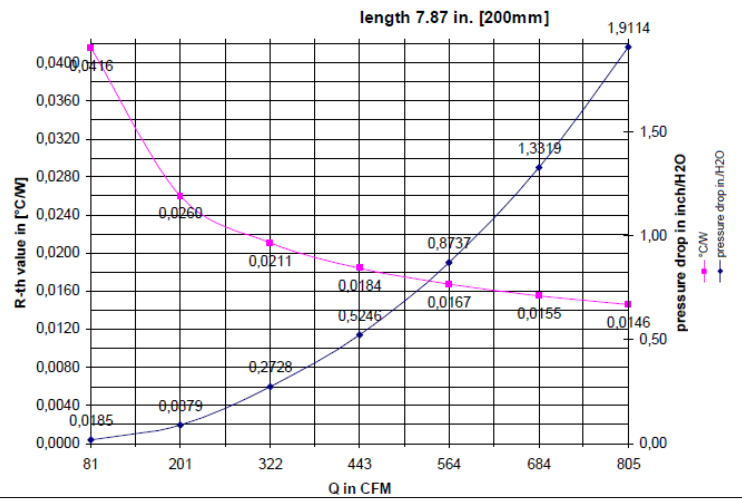

Resistenza termica (K/W) in ventilazione forzata

Lg. (mm)	200	300	400	500
R _{th} a 11m/s	0,0145	0,0115	0,0098	0,0087

length 11.81 in. [300mm]



FOTO DI ESEMPIO: TAGLIO PROFILO IN ALLUMINIO ESTRUSO PER LED DI GROSSE DIMENSIONI



DISSIPATORI AD ALTO RENDIMENTO

Disegni Meta' del Vero (1:2) - Scale 1:2

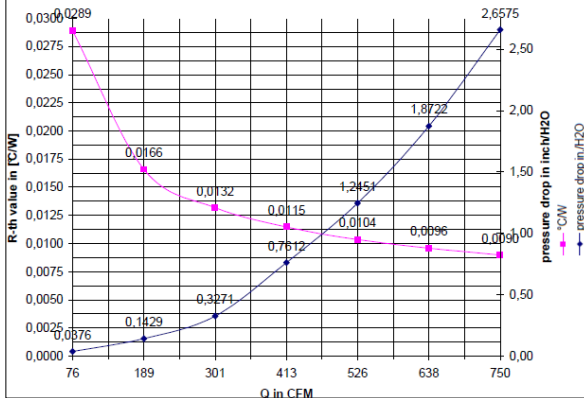
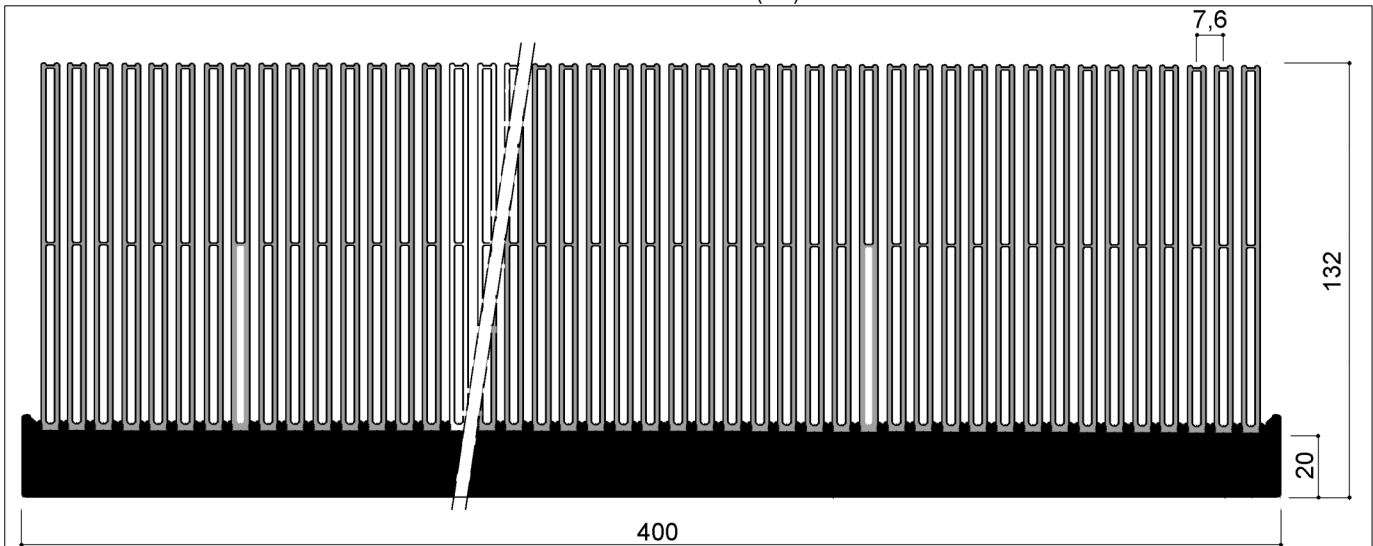

474

length 11.81 in. [300mm]

Resistenza termica (K/W) in ventilazione forzata

Lg. (mm)	200	300	400	500
R _{th} a 5m/s	0,0121	0,0092	0,0077	0,0067

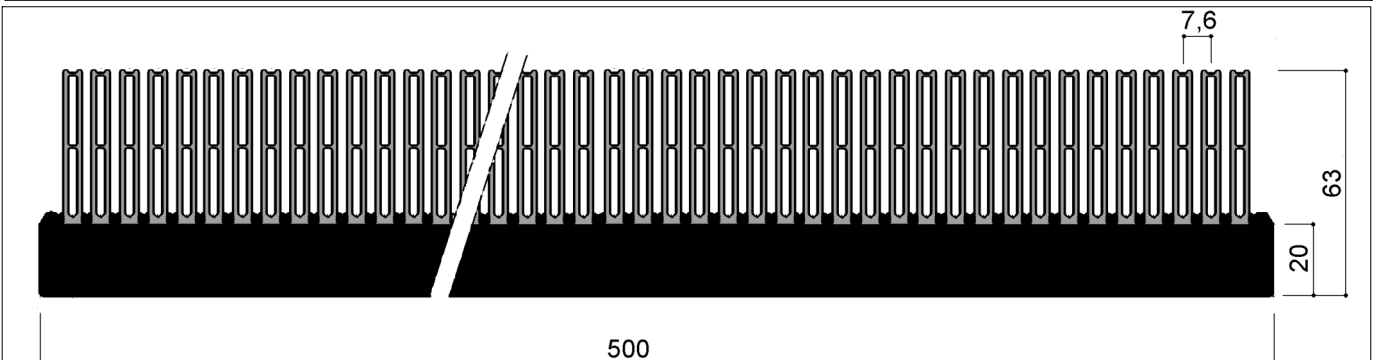
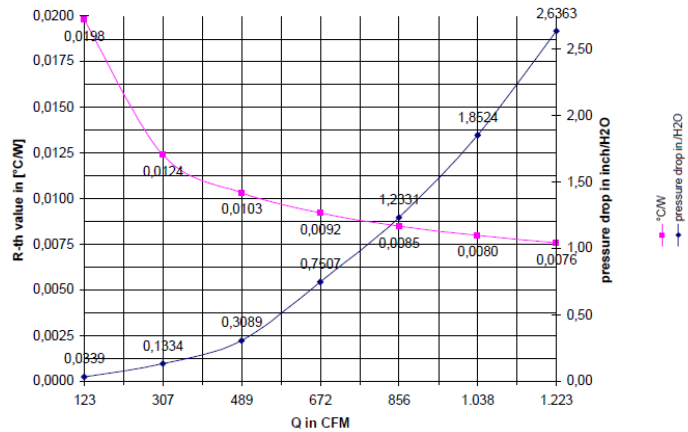

472

length 15.74 in. [400mm]

Resistenza termica (K/W) in ventilazione forzata

Lg. (mm)	200	300	400	500
R _{th} a 11 m/s	0,0162	0,0131	0,0114	0,0103

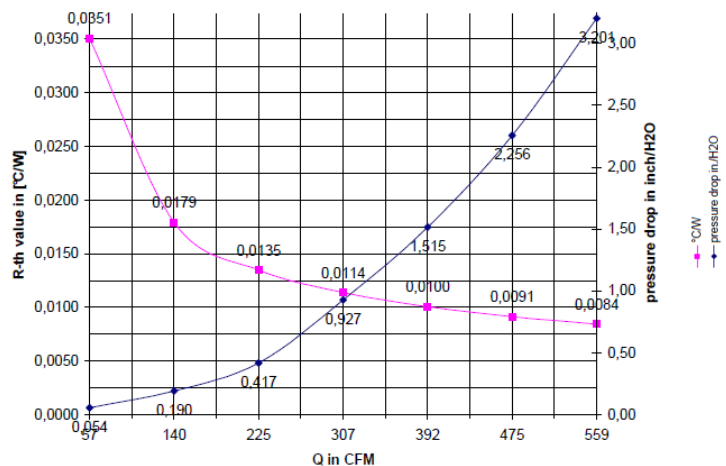

Via Newton, n.12
20016 Pero (Milano - Italy)
Tel.+39 02 3535955 r.a. Fax.+39 02 3539929
E-Mail: info@omar-alluminio.it

Cataloghi Online: www.omar-alluminio.it

www.omar-alluminio.com

PROFILATI ALLUMINIO A DISEGNO / STANDARD / SPECIALI / E PER:

ELETTRONICA / LED / FOTOVOLTAICO / AUTOMAZIONE ROBOTICA / PNEUMATICA / AUTOMOTIVE



DISSIPATORI AD ALTO RENDIMENTO



DISEGNI META' DEL VERO (1:2) - SCALE 1:2

Via Newton, n.12
20016 Pero (Milano - Italy)
Tel. +39 02 3535955 r.a. Fax. +39 02 3539929
E. Mail: info@omar-alluminio.it

Cataloghi Online: www.omar-alluminio.it
www.omar-alluminio.com

PROFILATI ALLUMINIO A DISEGNO / STANDARD / SPECIALI / E PER:
ELETTRONICA / LED / FOTOVOLTAICO / AUTOMAZIONE ROBOTICA / PNEUMATICA / AUTOMOTIVE

473

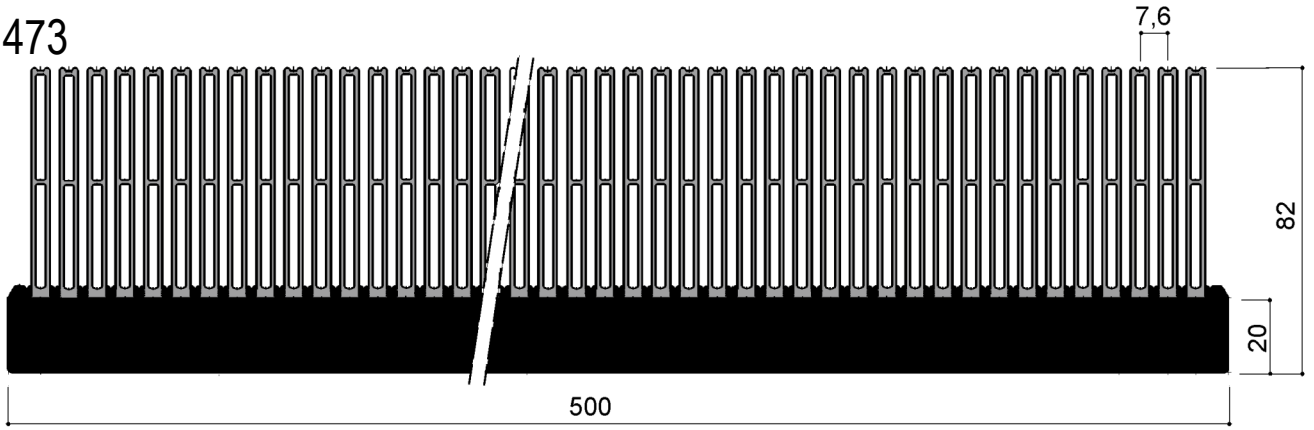

Resistenza termica (K/W) in ventilazione forzata

Lg. (mm)	200	300	400	500
R _{th} a 5m/s	0,0 129	0,0 102	0,0 087	0,0077

length 11.81 in. [300mm]

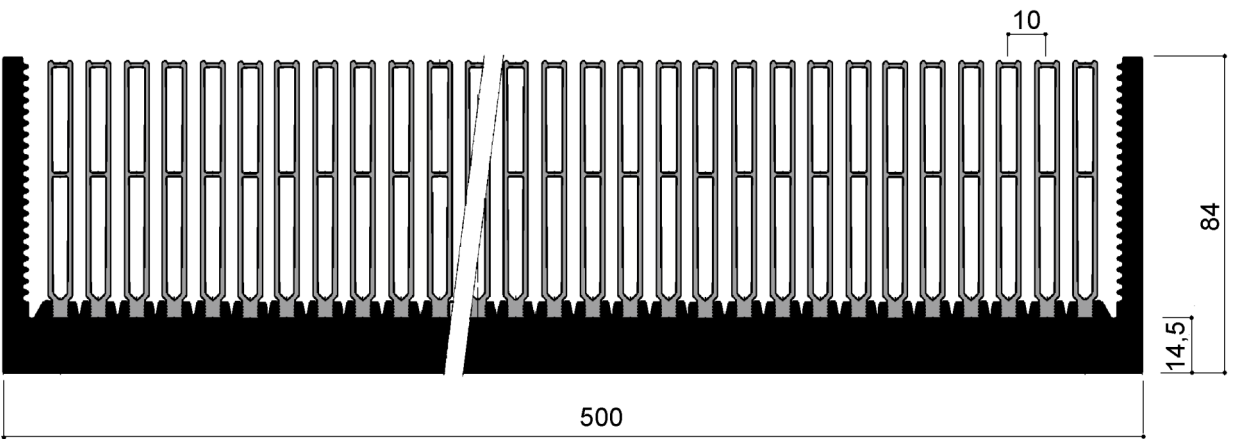
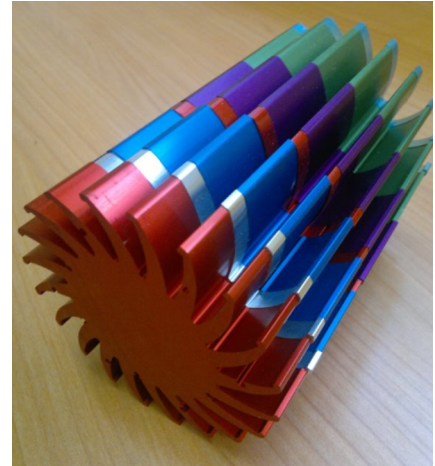
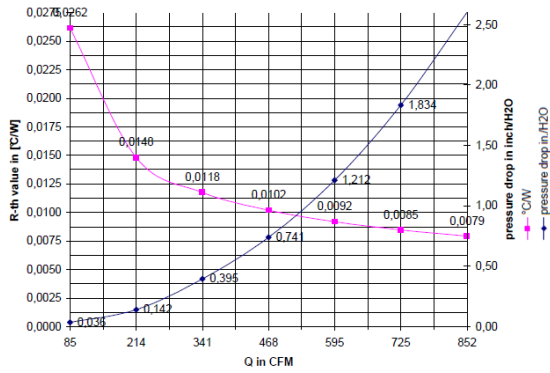

Resistenza termica (K/W) in ventilazione forzata

Lg. (mm)	100	200	300	400	500
R _{th} a 5m/s	0,0324	0,0215	0,0171	0,0147	0,0131

length 15.74 in. [400mm]

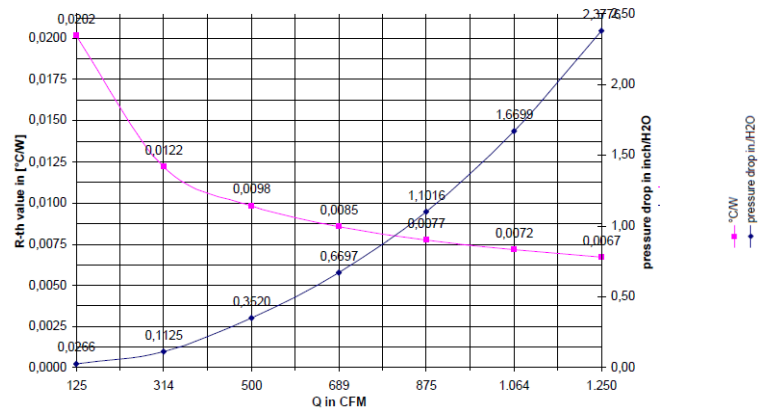

DISSIPATORI AD ALTO RENDIMENTO



DISEGNI META' DEL VERO (1:2)- SCALE 1:2

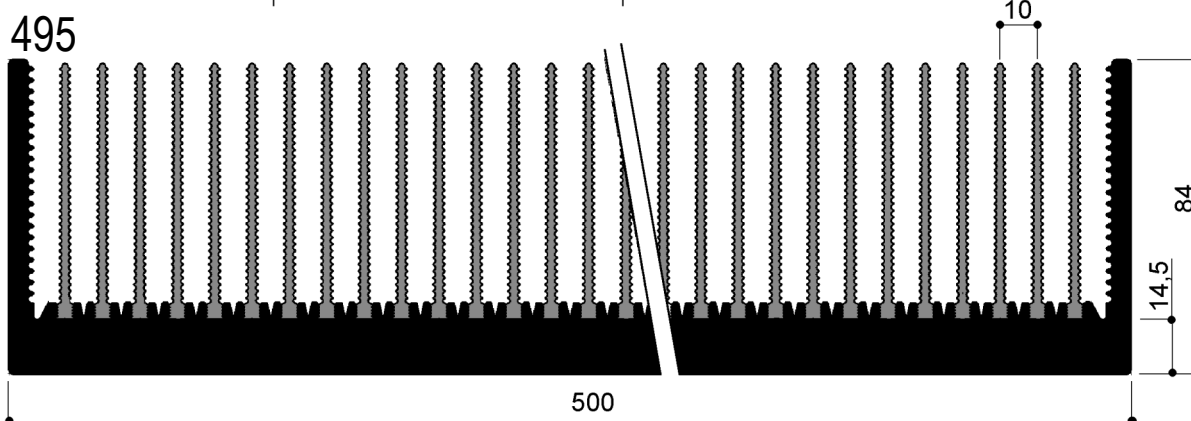

Resistenza termica (K/W) in ventilazione forzata

Lg. (mm)	100	200	300	400	500
R _{th} 5 m/s	0,0473	0,0317	0,0270	0,0215	0,0178

length 19.68 in. [500mm]

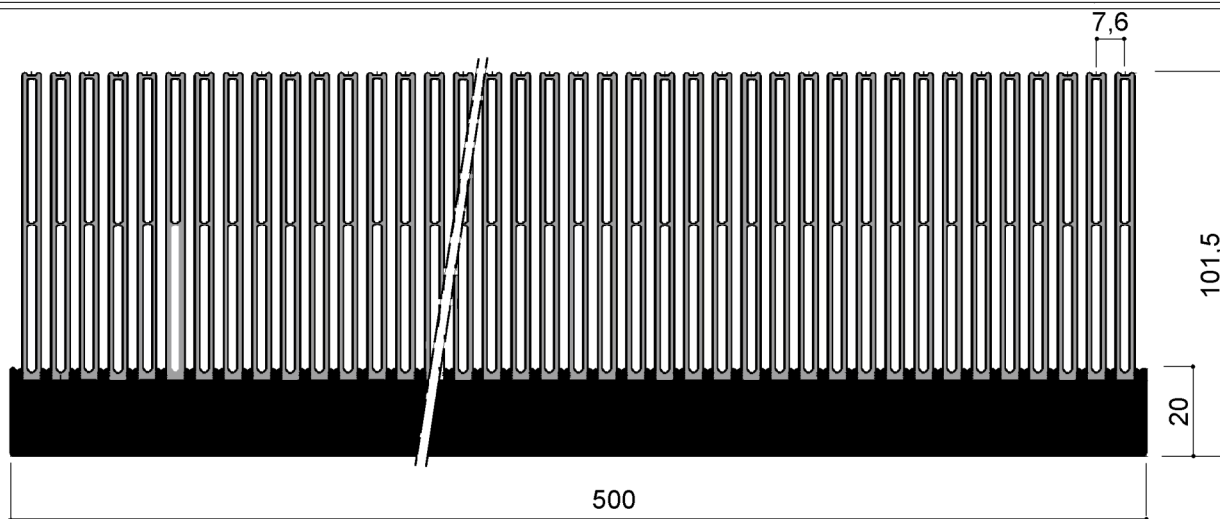
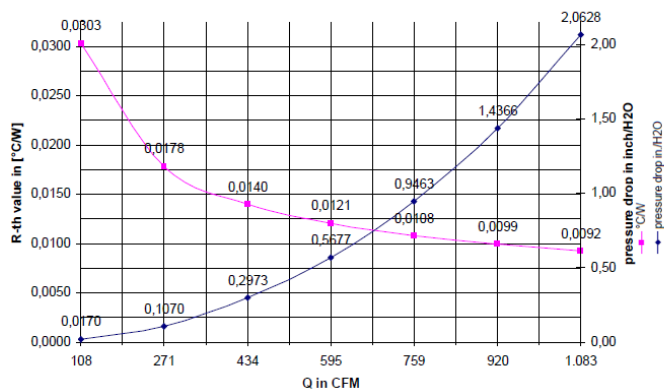

Resistenza termica (K/W) in ventilazione forzata

Lg. (mm)	200	300	400	500
R _{th} a 11 m/s	0,0109	0,0085	0,0072	0,0063

length 11.81 in. [300mm]

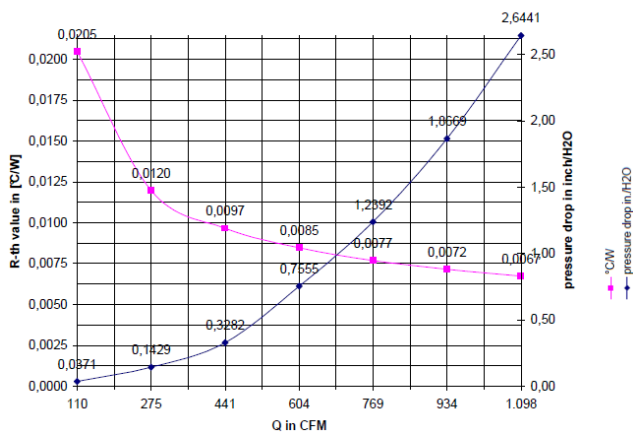

Via Newton, n.12

20016 Pero (Milano - Italy)

Tel. +39 02 3535955 r.a. Fax. +39 02 3539929

E-Mail: info@omar-alluminio.it

Cataloghi Online: www.omar-alluminio.it

www.omar-alluminio.com

PROFILATI ALLUMINIO A DISEGNO / STANDARD / SPECIALI / E PER:

ELETTRONICA / LED / FOTOVOLTAICO / AUTOMAZIONE ROBOTICA / PNEUMATICA / AUTOMOTIVE



DISSIPATORI AD ALTO RENDIMENTO

DISEGNI META' DEL VERO (1:2)- SCALE 1:2

Via Newton, n.12
20016 Pero (Milano - Italy)
Tel. +39 02 3535955 r.a. Fax. +39 02 3539929
E-Mail: info@omar-alluminio.it

Cataloghi Online: www.omar-alluminio.it
www.omar-alluminio.com

PROFILATI ALLUMINIO A DISEGNO / STANDARD / SPECIALI / E PER:
ELETTRONICA / LED / FOTOVOLTAICO / AUTOMAZIONE ROBOTICA / PNEUMATICA / AUTOMOTIVE

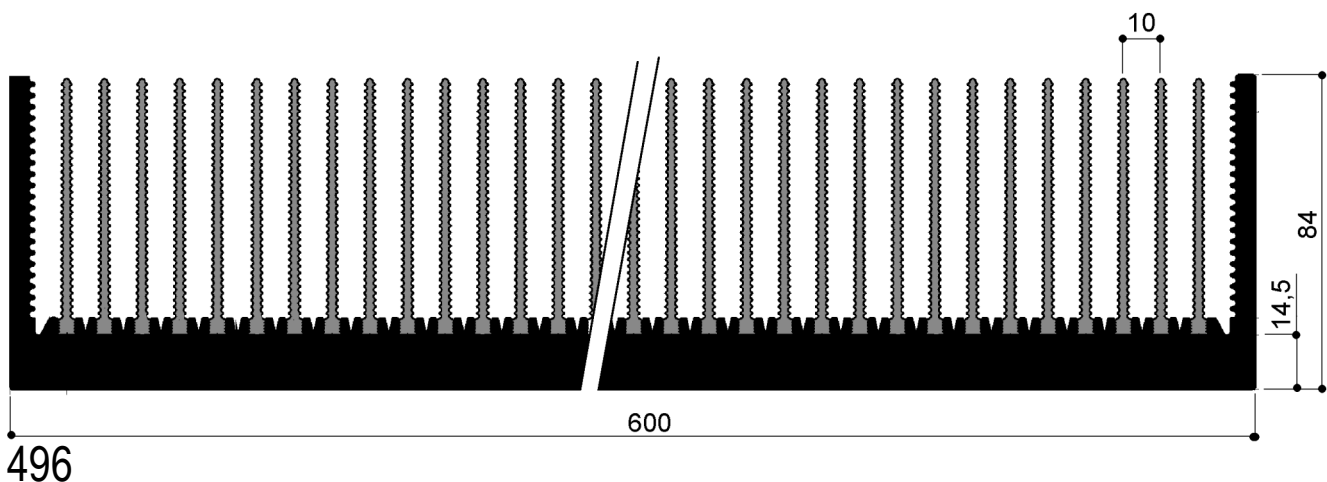
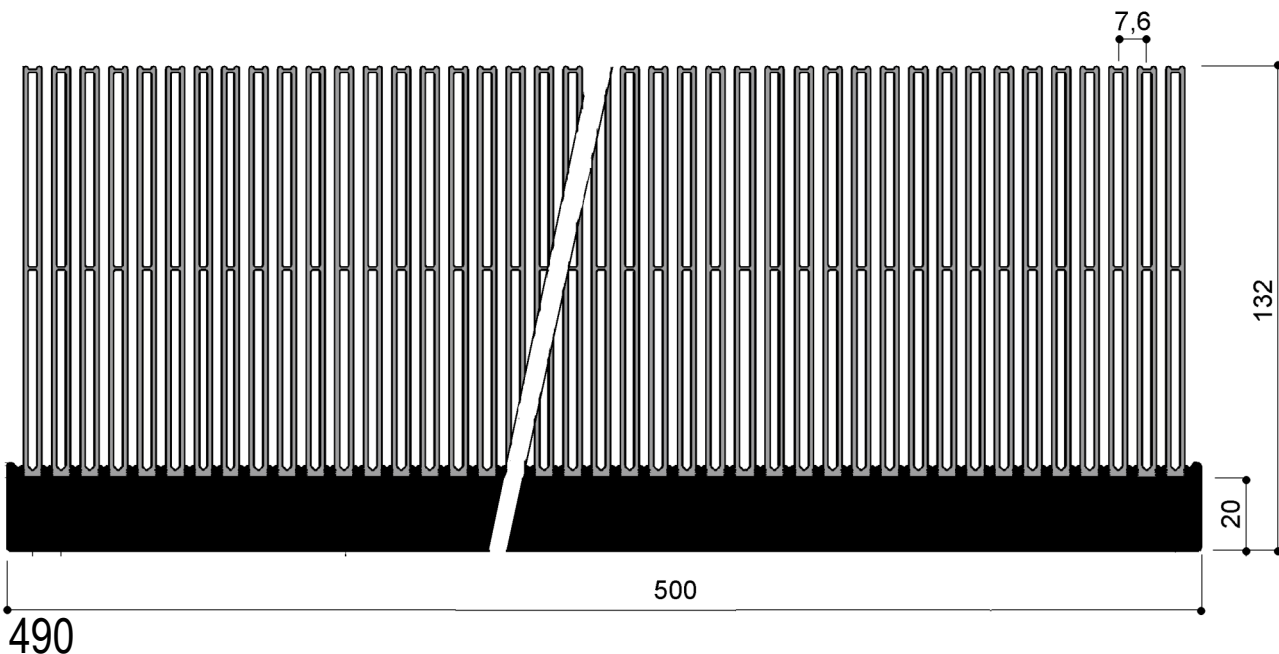

Resistenza termica (K/W) in ventilazione forzata

lg. (mm)	100	200	300	400	500	600
Rh 5 m/s	0,034	0,0263	0,0211	0,0182	0,0152	0,0134

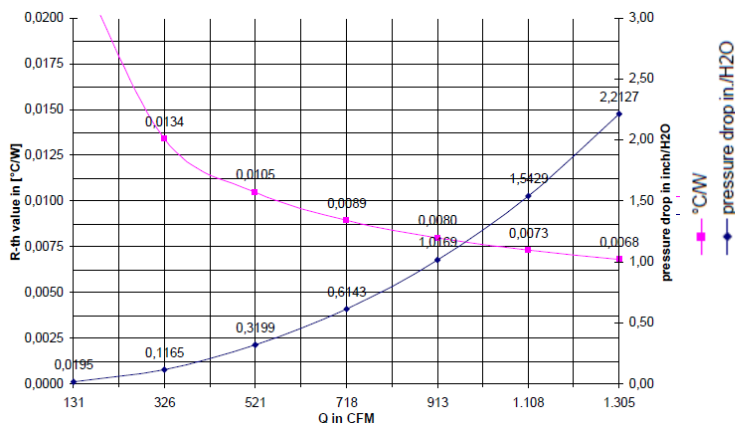

DISSIPATORI AD ALTO RENDIMENTO

DISEGNI META' DEL VERO (1:2)- SCALE 1:2

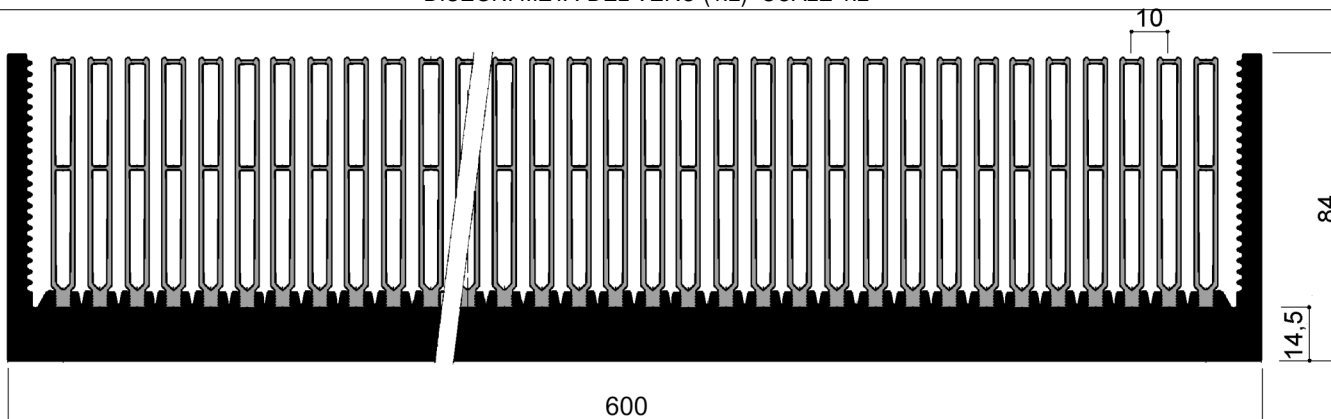

468

length 15.74 in. [400mm]

Resistenza termica (K/W) in ventilazione forzata

Lg. (mm)	100	200	300	400	500	600
R _{th} a 11 m/s	0,0269	0,0178	0,0142	0,0122	0,0109	0,0100

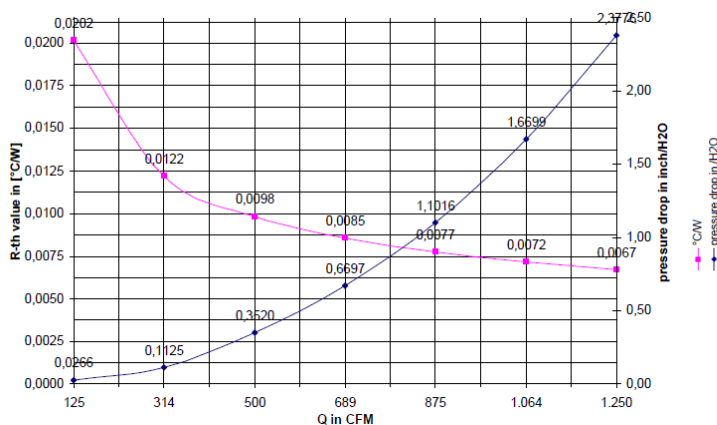

Via Newton, n.12

20016 Pero (Milano - Italy)

Tel. +39 02 3535955 r.a. Fax. +39 02 3539929

E-Mail: info@omar-alluminio.it

Cataloghi Online: www.omar-alluminio.it

www.omar-alluminio.com

PROFILATI ALLUMINIO A DISEGNO / STANDARD / SPECIALI / E PER:

ELETTRONICA / LED / FOTOVOLTAICO / AUTOMAZIONE ROBOTICA / PNEUMATICA / AUTOMOTIVE

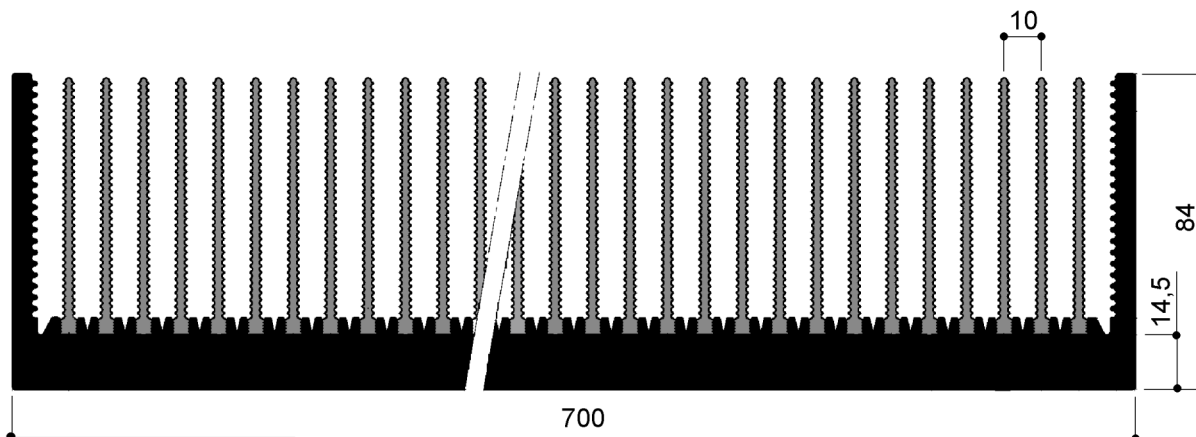

497

length 27.55 in. [700mm]

Resistenza termica (K/W) in ventilazione forzata

Lg. (mm)	200	300	400	500	600	700
R _{th}	0,0210	0,0168	0,0143	0,0121	0,0107	0,0099

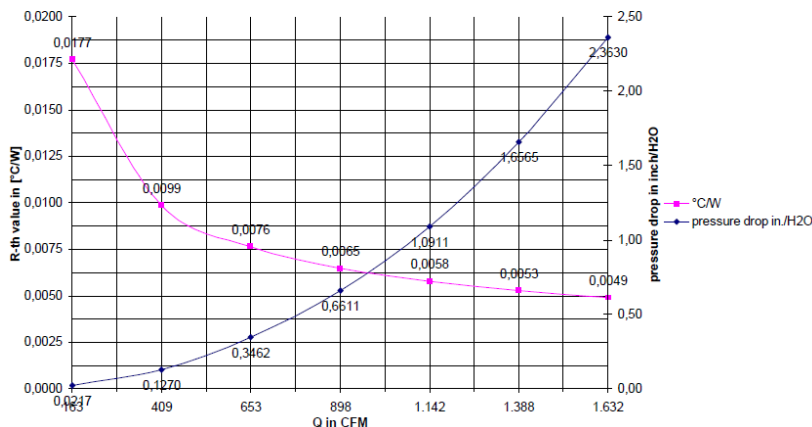

DISSIPATORI AD ALTO RENDIMENTO



Via Newton, n.12
20016 Pero (Milano - Italy)
Tel. +39 02 3535955 r.a. Fax. +39 02 3535929
E-Mail: info@omar-alluminio.it

Cataloghi Online: www.omar-alluminio.it
www.omar-alluminio.com
PROFILATI ALLUMINIO A DISEGNO / STANDARD / SPECIALI / E PER:
ELETTRONICA / LED / FOTOVOLTAICO / AUTOMAZIONE ROBOTICA / PNEUMATICA / AUTOMOTIVE

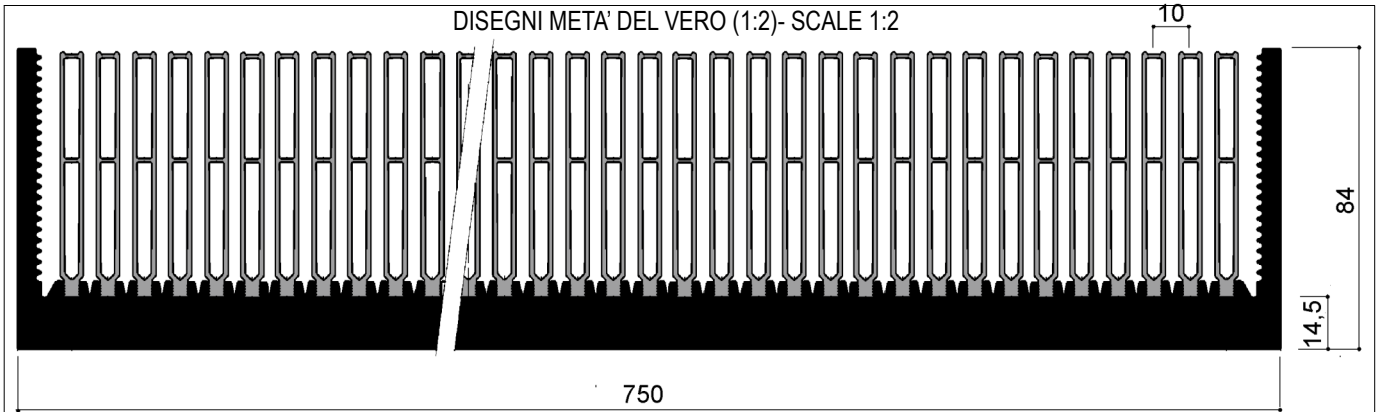

469

length 19.68 in. [500mm]

Resistenza termica (K/W) in ventilazione forzata

Lg. (mm)	200	300	400	500	600	700
R _{th} a 5m/s	0,0142	0,0113	0,0097	0,0087	0,008	0,0074

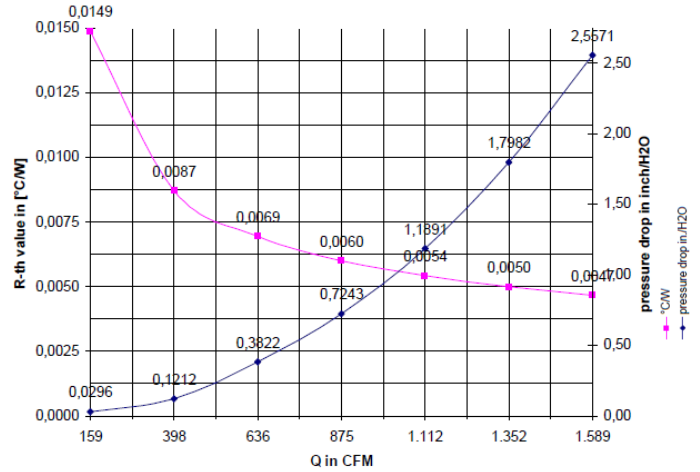

I valori espressi dalle curve sono puramente indicativi

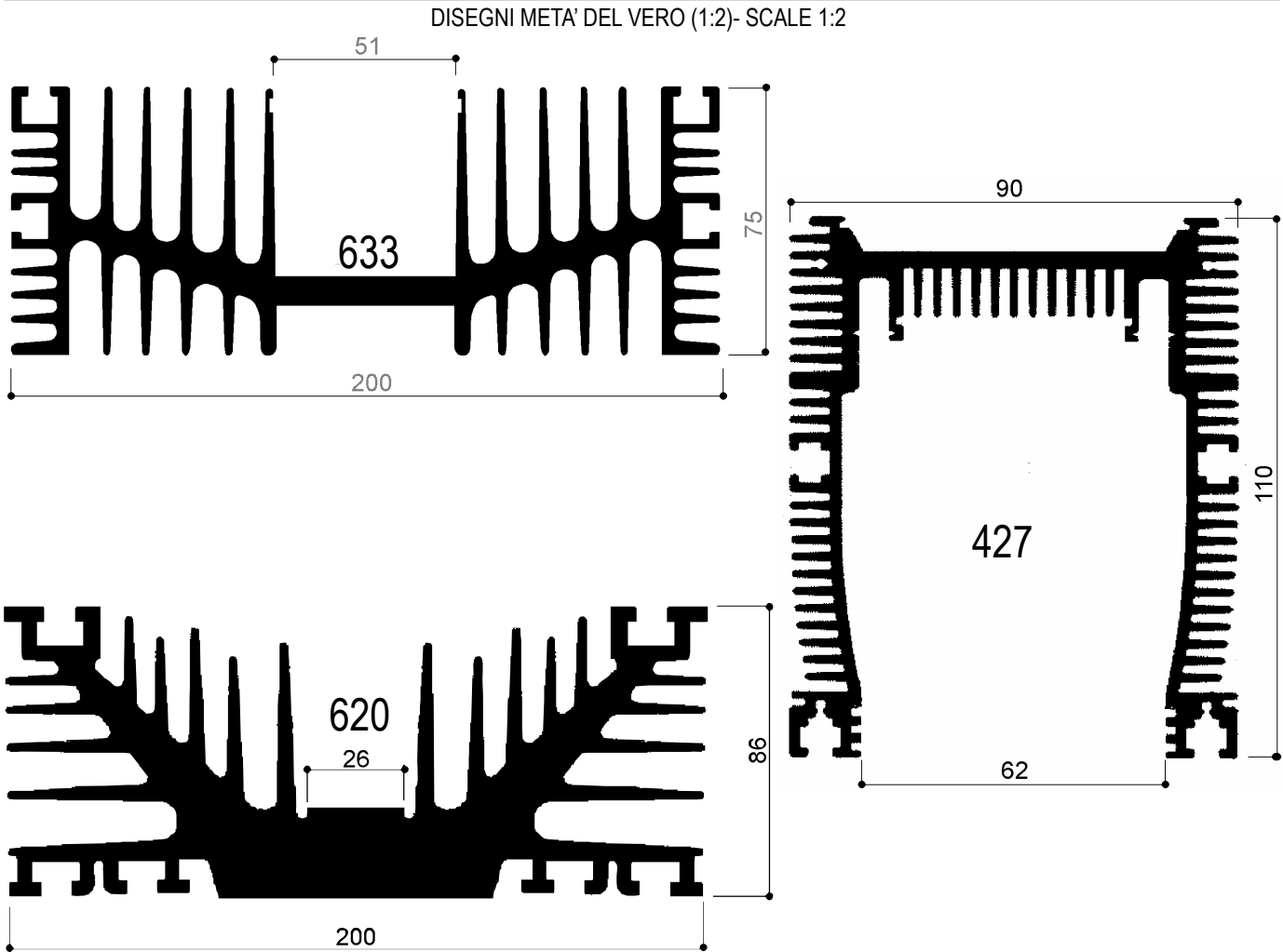

FIERA MILANO RHO - PERO

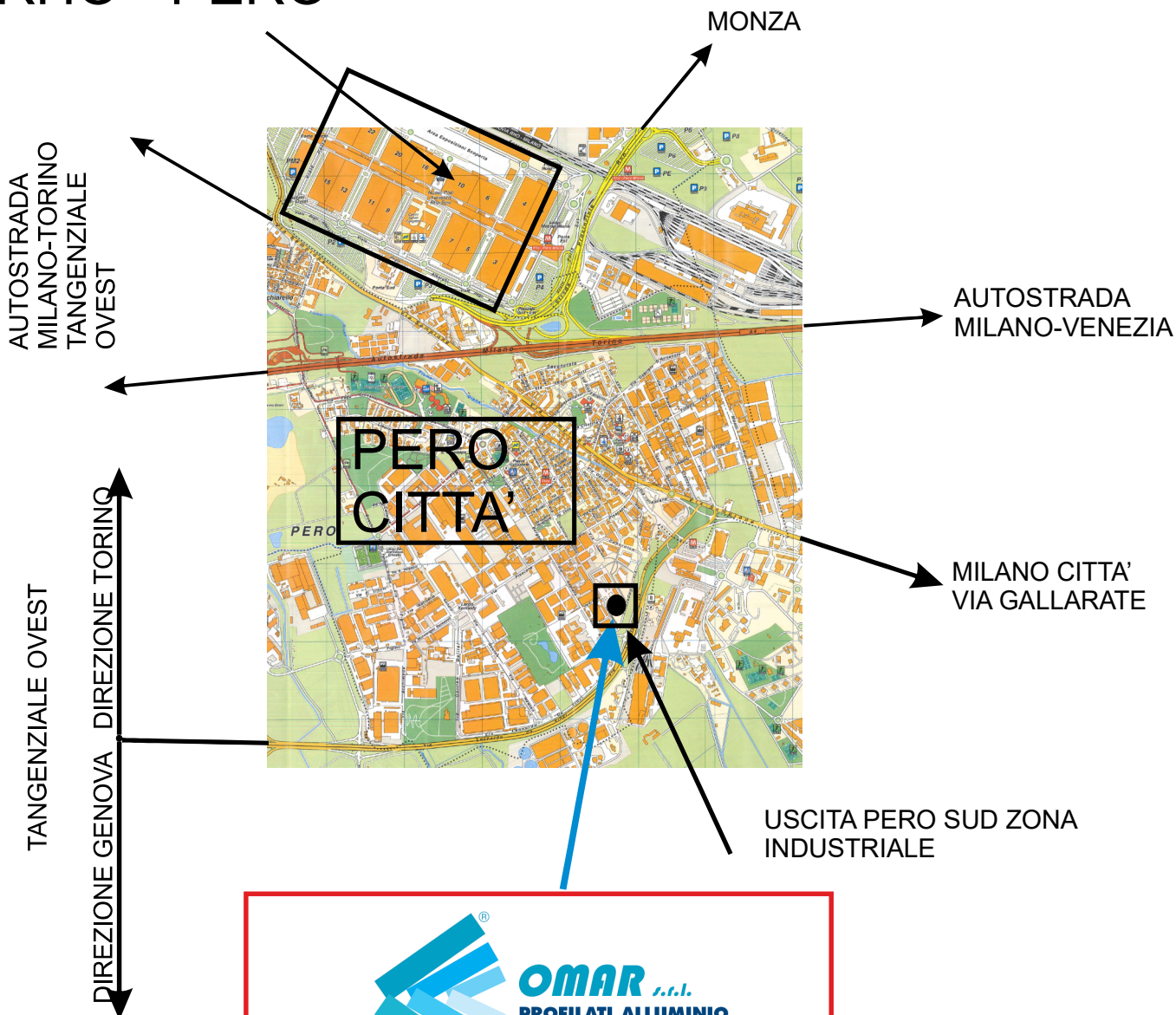

OMAR s.r.l.
PROFILATI ALLUMINIO
ALTA TECNOLOGIA

Via Newton, n.12
20016 Pero (Milano - Italy)
Tel.+39 02 3535955 r.a.
Fax.+39 02 3539929
E.Mail: info@omar-alluminio.it

Consultate il ns. catalogo aggiornato online all'indirizzo:

www.omar-alluminio.it
www.omar-alluminio.com
www.omar-alluminio.eu

PROFILATI IN ALLUMINIO
A DISEGNO-STANDARD-SPECIALI



E PER: ELETTRONICA-LED-FOTOVOLTAICO
AUTOMAZIONE ROBOTICA-PNEUMATICA-AUTOMOTIVE